

# ***RENOLD***

## SECTION 4

CONVEYOR CHAIN DESIGNER GUIDE

Selecting the right chain for a given application is essential to obtain long service life. This guide has been developed for use with Renold conveyor chain to help in specifying the right chain and lubrication for your conveyor system. The significance of the Renold conveyor chain design is emphasised, followed by guidance on selection procedure. Detailed descriptions are given of the various methods of application in a variety of mechanical handling problems and under widely varying conditions. The supporting material includes various reference tables and statistics.

From the pyramids to the railway revolution, muscle-power of men and animals has moved goods and materials, but throughout history, machines, however primitive, have played some part, becoming more and more versatile.

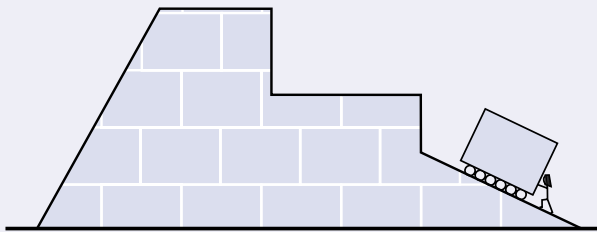

Within the immediate past, mechanical handling has emerged as a manufacturing industry in its own right, of considerable size and with countless applications. This is a consequence of its coverage, which now ranges from the simplest store conveyor system to the largest flow line production layouts, and also includes the movement of personnel by lifts, escalators and platforms.

Amongst the most widely used types of handling equipment are conveyors, elevators and similar assemblies. These can take many forms, employing as their basic moving medium both metallic and non-metallic components or a mixture of the two.

For the great majority of applications Renold conveyor chain in its many variations, when fitted with suitable attachments, provides a highly efficient propulsion and/or carrying medium, having many advantages over other types. Roller chain has been employed as an efficient means of transmitting power since it was invented by Hans Renold in 1880. Later the principle was applied to conveyor chain giving the same advantages of precision, heat-treated components to resist wear, high strength to weight ratio and high mechanical efficiency.

Renold conveyor chain is made up of a series of inner and outer links. Each link comprises components manufactured from materials best suited to their function in the chain; the various parts are shown in Figure 1. An inner link consists of a pair of inner plates which are pressed onto cylindrical bushes, whilst on each bush a free fitting roller is normally assembled. Each outer link has a pair of outer plates which are pressed onto bearing pins and the ends of the pins are then rivetted over the plate.

Fig. 1

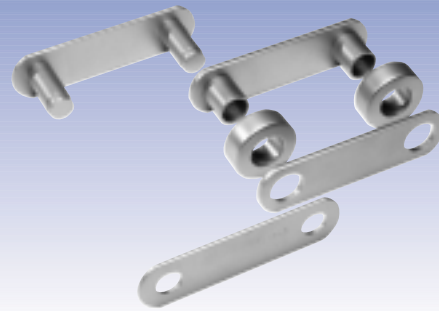

From the foregoing, it will be seen that a length of chain is a series of plain journal bearings free to articulate in one plane. When a chain articulates under load the friction between pin and bush, whilst inherently low because of the smooth finish on the components, will tend to turn the bush in the inner plates and similarly the bearing pin in the outer plate. To prevent this the bush and pin are force fitted into the chain plates. Close limits of accuracy are applied to the diameters of plate holes, bushes and bearing pins, resulting in high torsional security and rigidity of the mating components. Similar standards of accuracy apply to the pitch of the holes in the chain plates.

To ensure optimum wear life the pin and bush are hardened. The bush outside diameter is hardened to contend with the load carrying pressure and gearing action, both of which are imparted by the chain rollers. Chain roller material and diameter can be varied and are selected to suit applicational conditions; guidance in roller selection is given on page 73. Materials used in chain manufacture conform to closely controlled specifications. Manufacture of components is similarly controlled both dimensionally and with regard to heat treatment.

For a given pitch size of transmission chain, there is normally a given breaking load. However, conveyor chain does not follow this convention. For each breaking load, conveyor chain has multiple pitch sizes available. The minimum pitch is governed by the need for adequate sprocket tooth strength, the maximum pitch being dictated by plate and general chain rigidity. The normal maximum pitch can be exceeded by incorporating strengthening bushes between the link plates, and suitable gaps in the sprocket teeth to clear these bushes.

## CHAIN TYPES

There are two main types of conveyor chain - hollow bearing pin and solid bearing pin.

### Hollow Bearing Pin Chain

Hollow pin conveyor chain offers the facility for fixing attachments to the outer links using bolts through the hollow pin and attachment, this method of fixing being suitable for use in most normal circumstances. The attachments may be bolted up tight or be held in a 'free' manner. Bolted attachments should only span the outer link as a bolted attachment spanning the inner link would impair the free articulation of the chain.

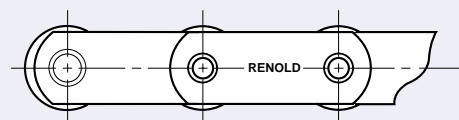

## Solid Bearing Pin Chain

Solid bearing pin chain, while having exactly the same gearing dimensions in the BS series of chain as the equivalent hollow pin chain, i.e. pitch, inside width and roller diameter, is more robust with a higher breaking load and is recommended for use where more arduous conditions may be encountered.

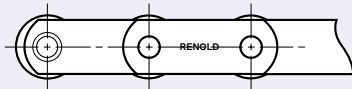

## Deep Link Chain

Hollow and solid pin chain has an optional side plate design known as deep link. This chain's side plates have greater depth than normal, thus providing a continuous carrying edge above the roller periphery.

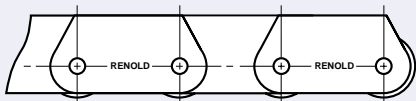

## INTERNATIONAL STANDARDS

Conveyor chain, like transmission chain, can be manufactured to a number of different international standards. The main standards available are:

### British Standard - BS

This standard covers chain manufactured to suit the British market and markets where a strong British presence has dominated engineering design and purchasing. The standard is based on the original Renold conveyor chain design.

### ISO Standard

Chain manufactured to ISO standards is not interchangeable with BS or DIN standard chain. This standard has a wide acceptance in the European market, except in Germany. Chain manufactured to this standard is becoming more popular and are used extensively in the Scandinavian region.

## CHAIN ATTACHMENTS

An attachment is any part fitted to the basic chain to adapt it for a particular conveying duty, and it may be an integral part of the chain plate or can be built into the chain as a replacement for the normal link.

### K Attachments

These are the most popular types of attachment, being used on slat and apron conveyors, bucket elevators etc. As shown in Fig. 2 they provide a platform parallel to the chain and bearing pin axes. They are used for securing slats and buckets etc. to the chain. Either one or two holes are normally provided in the platform, being designated K1 or K2 respectively. K attachments can be incorporated on one or both sides of the chain. For the more important stock pitches where large quantities justify the use of special manufacturing equipment, the attachments are produced as an integral part of the chain, as shown in Fig. 2(a). Here the platform is a bent over extension of the chain plate itself.

On other chain or where only small quantities are involved, separate attachments are used, as shown in Fig. 2(b). These are usually welded to the chain depending on the particular chain series and the application. Alternatively, (see Fig 2(c)), K attachments may be bolted to the chain either through the hollow bearing pins, or by using special outer links with extended and screwed bearing pin ends.

Fig. 2

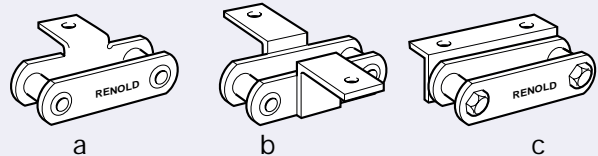

- (a) K1 bent over attachment.
- (b) K1 attachment, welded to link plate.
- (c) K2 attachment bolted through hollow bearing pin.

### F Attachments

These attachments as shown in Fig. 3 are frequently used for pusher and scraper applications. They comprise a wing with a vertical surface at right angles to the chain. They can be fitted to one or both sides and are usually secured by welding. Each wing can be provided with one or two holes, being designated F1 or F2 respectively.

Fig. 3

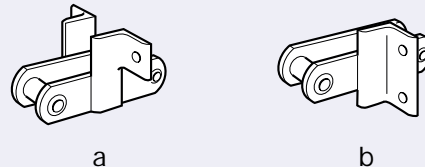

- (a) F1 attachments welded to link plates on one or both sides of the chain as required.
- (b) F2 attachments welded to link plates on one or both sides of the chain as required.

### Spigot Pins and Extended Bearing Pins

Both types are used on pusher and festoon conveyors and tray elevators, etc. Spigot pins may be assembled through hollow bearing pins, inner links or outer links. When assembled through link plates a spacing bush is necessary to ensure that the inside width of the chain is not reduced. Gapping of the sprocket teeth is necessary to clear the bush.

Solid bearing pin chains can have similar extensions at the pitch points by incorporating extended pins. Both spigot pins and extended pins, as shown in Fig. 4, can be case-hardened on their working diameters for increased wear resistance.

Fig. 4

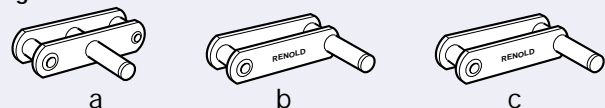

- (a) Spigot pin assembled through outer or inner link.
- (b) Spigot pin bolted through hollow bearing pin.
- (c) Extended bearing pin.

### Staybars

Types of mechanical handling equipment that use staybars are pusher, wire mesh, festoon conveyors, etc., the staybars being assembled in the same manner as spigot pins. When assembled through link plates a spacing bush and gapping of the sprocket teeth are necessary.

The plain bar-and-tube type shown in Fig. 5 has the advantage that the staybar can be assembled with the chain in situ by simply threading the bar through the chain and tube. The shouldered bar type has a greater carrying capacity than the bar-and-tube type. Staybars are normally used for either increasing overall rigidity by tying two chains together, maintaining transverse spacing of the chains, or supporting loads.

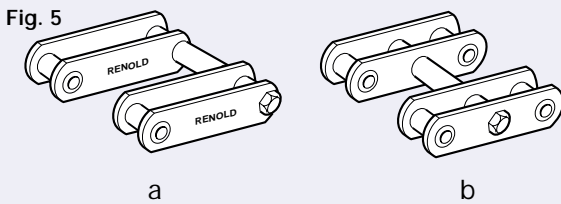

(a) Staybar bolted through hollow bearing pin.  
(b) Staybar assembled through outer or inner link.

### G Attachments

As shown in Fig. 6 this attachment takes the form of a flat surface positioned against the side of the chain plate and parallel to the chain line. It is normally used for bucket elevators and pallet conveyors. When the attachment is integral with the outer plate then the shroud of the chain sprocket has to be removed to clear the plate. G Attachments are normally fitted only to one side of the chain.

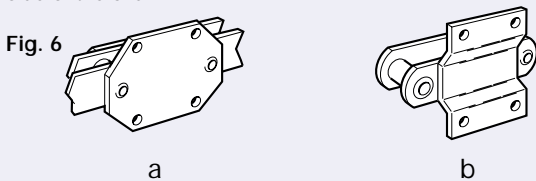

(a) G2 attachment outer plate.  
(b) G2 attachment, welded or rivetted to link plate.

### L Attachments

These have some affinity with the F attachment, being in a similar position on the chain. A familiar application is the box scraper conveyor. As shown in Fig. 7 the attachments are integral with the outer plates, being extended beyond one bearing pin hole and then bent round. The attachments can be plain or drilled with one or two holes, being designated L0, L1 or L2 respectively. They can be supplied on one or both sides of the chain. With this type of attachment the chain rollers are normally equal to the plate depth, or a bush chain without rollers is used.

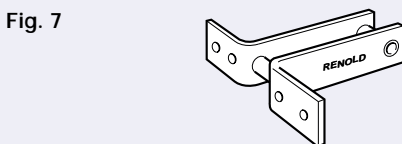

L2 attachments on both sides of the outer link.

### S and Pusher Attachments

These are normally used on dog pusher conveyors. As shown in Fig. 8 the S attachment consists of a triangular plate integral with the chain plate; it can be assembled on one or both sides of the chain, but may also be assembled at the inner link position. S

attachments are intended for lighter duty, but for heavier duty a pair of attachments on one link is connected by a spacer block to form a pusher attachment. This increases chain rigidity and pushing area.

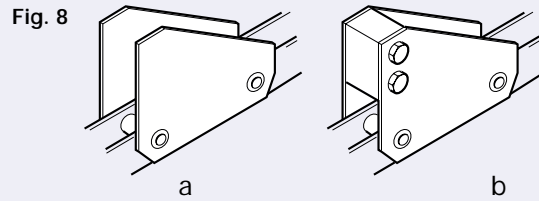

(a) S attachment outer plate; assembled on one or both sides of chain as required.  
(b) Pusher attachment.

### Drilled Link Plates

Plates with single holes as shown in Fig. 9(a) are associated with the fitting of staybars or spigot pins. Where G or K attachments are to be fitted then link plates with two holes as shown in Fig. 9(b) are used. Where attachments are fitted to inner links then countersunk bolts must be used to provide sprocket tooth clearance.

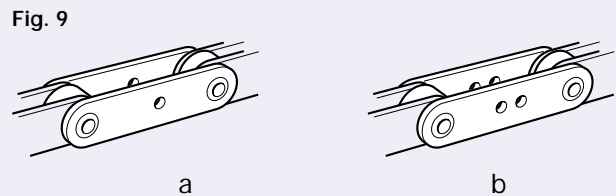

### Outboard Rollers

The main reasons for using outboard rollers are that they increase roller loading capacity of the chain and provide a stabilised form of load carrier. As shown in Fig. 10 the outboard rollers are fixed to the chain by bolts which pass through hollow bearing pins. Outboard rollers have the advantage that they are easily replaced in the event of wear and allow the chain rollers to be used for gearing purposes only.

Fig. 10 Outboard rollers.

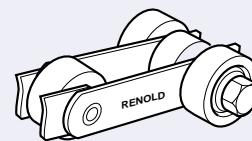

### Chain Joints

Conveyor chain is normally supplied in convenient handling lengths, these being joined by means of outer connecting links. This can be accomplished by the use of any of the following:

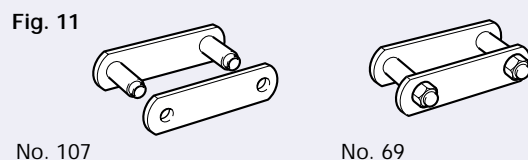

Outer link used for rivetting chain endless. It is particularly useful in hollow bearing pin chains where the hollow pin feature is to be retained.

Bolt-type connecting link with solid bearing pin. Loose plate is a slip fit on the bearing pins and retained by self locking nuts.

Fig. 12

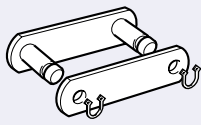

No. 58

On lower breaking strength chain a soft circlip retains the connecting plate in position on the pins, the connecting plate being an interference fit on the bearing pins.

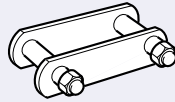

No. 86

A modified version of the bolt-type connecting link. The connecting pins are extended to permit the fitment of attachments on one side of the chain only.

Fig. 13

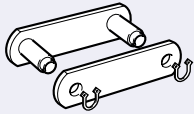

No. 11

For 4,500 lbf series chain only, circlips are fitted to both ends of hollow connecting pins.

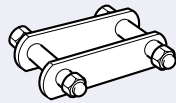

No. 85

Similar to No. 86 but allows attachments to be bolted to both sides of the chain.

### Advantages of Renold Conveyor Chain

These can be summarised as follows:-

- Large bearing areas and hardened components promote maximum life.
- Low friction due to a smooth finish of the components.
- The inclusion of a chain roller and the high strength to weight ratio enable lighter chain selection and lower power consumption.
- The use of high grade materials ensures reliability on onerous and arduous applications.
- The facility to obtain a variety of pitches with each chain breaking strength and a variation in attachment types provides adaptability.
- The accuracy of components provides consistency of operation, accurate gearing and low sprocket tooth wear. The latter is particularly important in multistrand systems where equal load distribution is vital.

## BASIC REQUIREMENTS

To enable the most suitable chain to be selected for a particular application it is necessary to know full applicational details such as the following:

Type of conveyor.

Conveyor centre distance and inclination from the horizontal.

Type of chain attachment, spacing and method of fixing to the chain.

Number of chains and chain speed.

Details of conveying attachments, e.g. weight of slats, buckets, etc.

Description of material carried, i.e. weight, size and quantity.

Method of feed and rate of delivery.

### Selection of Chain Pitch

In general the largest stock pitch possible consistent with correct operation should be used for any application, since economic advantage results from the use of the reduced number of chain components per unit length. Other factors include size of bucket or slats etc., chain roller loading (see Page 73) and the necessity for an acceptable minimum number of teeth in the sprockets where space restriction exists.

## CHAIN PULL CALCULATIONS

The preferred method of calculating the tension in a conveyor chain is to consider each section of the conveyor that has a different operating condition. This is particularly necessary where changes in direction occur or where the load is not constant over the whole of the conveyor.

For uniformly loaded conveyors there is a progressive increase in chain tension from theoretically zero at A to a maximum at D. This is illustrated graphically in Fig. 14 where the vertical distances represent the chain tension occurring at particular points in the circuit, the summation of which gives the total tension in the chain.

Fig. 14

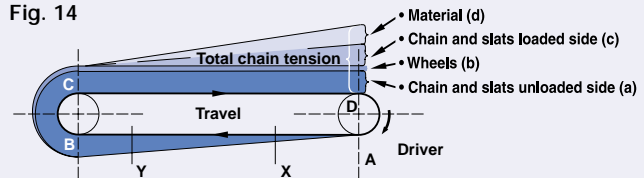

Thus, in Fig. 14 the maximum pull at D comprises the sum of:

- Pull due to chain and moving parts on the unloaded side.
- Extra pull required to turn the idler wheels and shaft.
- Pull due to chain and moving parts on the loaded side.
- Pull due to the load being moved.

If it is imagined that the chains are 'cut' at position X then there will be a lower load pull or tension at this position than at Y. This fact is significant in the placing of caterpillar drives in complex circuits and also in assessing tension loadings for automatic take-up units.

This principle has been used to arrive at the easy reference layouts and formulae (Page 80 - 81) to which most conveyor and elevator applications should conform. Where conveyors do not easily fit these layouts and circuits are more complex then see page 82 or consult Renold Applications Department for advice.

## FACTORS OF SAFETY

Chain manufacturers specify the chain in their product range by breaking load. Some have quoted average breaking loads, some have quoted minimum breaking loads depending upon their level of confidence in their product. Renold always specify minimum breaking load. To obtain a design working load it is necessary to apply a "factor of safety" to the breaking load and this is an area where confusion has arisen.

As a general rule, Renold suggest that for most applications a factor of safety of 8 is used,

$$\text{Working Load} = \frac{\text{Breaking Load}}{8}$$

On first inspection, a factor of safety of 8 seems very high and suggests that the chain could be over-selected if this factor is applied.

If, however, we examine the situation in detail, the following points arise:-

1. Most chain side plates are manufactured from low or medium carbon steel and are sized to ensure they have adequate strength and resistance to shock loading.
2. These steels have yield strengths that vary from 50% to 65% of their ultimate tensile strength. This means that if chains are subjected to loads of 50% to 65% of their breaking load, then permanent pitch extension is likely to occur.

Fig. 15

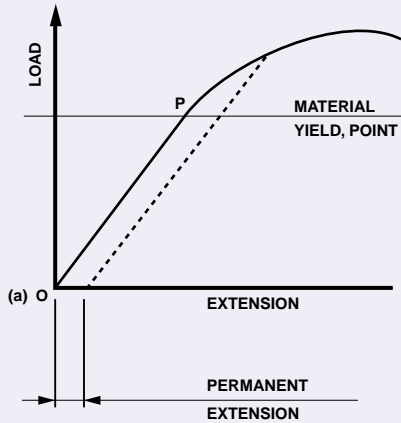

3. It is the tendency to over-select drive sizes "just to be sure the drive is adequate", and the motors used today are capable of up to 200% full load torque output for a short period.
4. The consequences of this are that a chain confidently selected with a factor of safety of 8 on breaking load is in effect operating with a factor of safety of as low as 4 on the yield of the material, and 2 when the possible instantaneous overload on the drive is considered, and this is without considering any over-selection of the motor nominal power.
5. A further consideration when applying a factor of safety to a chain application is the chain life.

The tension applied to a chain is carried by the pin/bush interface which at the chain sprockets articulates as a plain bearing.

Experience has shown that, given a good environment, and a clean and well lubricated chain, a bearing pressure of up to 24N/mm<sup>2</sup> (3500 lb/inch<sup>2</sup>) will give an acceptable pin/bush life. A safety factor of 8 will give this bearing pressure.

In anything other than a clean well lubricated environment the factor of safety should be increased, thus lowering the bearing pressure, if some detriment to the working life of the chain is to be avoided.

Table 1 gives a general guide to the appropriate safety factors for different applications.

Table 1 - Factors of Safety

CLEANLINESS/LUBRICATION				
Lubrication	Clean	Moderately Clean	Dirty	Abrasive
Regular	8	10	12	14
Occasional	10	12	14	16
None	12	14	16	18

### TEMPERATURE/LUBRICATION

Lubrication	-30 / +150°C	150 - 200°C	200 - 300°C
Regular	8	10	12
Occasional	10	12	14
None	12	14	16

In all the listed applications and conditions, the increase in factor of safety is applied with the object of lowering the pin/bush bearing pressure to improve the chain life.

## CHAIN LIFE

4

There are a number of factors affecting the life of a chain in a particular environment.

- The load on the chain and therefore the bearing pressure between the pin and the bush.**  
The design of conveyor chain is such that at the calculated working load of the chain (relative to the breaking load) then the bearing pressure between the pin and the bush will be at a maximum of 24N/mm<sup>2</sup> (3500lb/in<sup>2</sup>) for a clean well lubricated environment.  
This pressure should be reduced for anything less than clean, well lubricated conditions and this is allowed for by increasing the factor of safety as shown in table 1.
- The characteristics of the material handled, i.e. abrasiveness, etc.**  
Some materials are extremely abrasive and if the material cannot be kept away from the chain then the bearing pressure must be reduced to lessen the effect of the abrasion. It is possible to improve the abrasion resistance of chain components by more sophisticated heat treatments at extra cost but the usual way of ensuring an acceptable life is to reduce the bearing pressure. See page 98 for the abrasive characteristics of materials. In some instances it is possible to use block chain to improve chain life, see page 88.
- Corrosion.**  
Some materials are aggressive to normal steels and the nature of the attack will be to reduce the side plate section and therefore the chain strength, or cause pitting of the pin, bush and roller surfaces.  
The pitting of the surface has the effect of reducing the bearing area of the component and therefore increasing the bearing pressure and wear rate. The process will also introduce (onto the bearing surfaces) corrosion products which are themselves abrasive.  
Materials such as Nitrates will cause the failure of stressed components due to nitrate stress cracking.  
Page 104 shows some materials together with their corrosive potential for various chain materials.
- Maintenance by the end user is one of the most important factors governing the life of a chain.**  
For the basic maintenance measures required to obtain the maximum useful life from your chain consult the Installation and Maintenance section.

### ASSESSMENT OF CHAIN ROLLER FRICTION

In conveyor calculations the value of the coefficient of friction of the chain roller has a considerable effect on chain selection. When a chain roller rotates on a supporting track there are two aspects of friction to be considered. Firstly there is a resistance to motion caused by rolling friction and the value for a steel roller rolling on a steel track is normally taken as 0.00013. However this figure applies to the periphery and needs to be related to the roller diameter, therefore:

$$\text{Coefficient of rolling friction} = \frac{0.00013}{\text{Roller radius (m)}} = \frac{0.13}{\text{Roller radius (mm)}} = \frac{0.26}{\text{Roller diameter (mm)}}$$

Secondly a condition of sliding friction exists between the roller bore and the bush periphery. For well lubricated clean conditions a coefficient of sliding friction  $\mu_F$  of 0.15 is used and for poor lubrication approaching the unlubricated state, a value of 0.25 should be used. Again this applies at the bush/roller contact faces and needs to be related to their diameters.

$$\text{Coefficient of sliding friction} = \frac{\mu_F \times \text{Roller bore (mm)}}{\text{Roller diameter (mm)}}$$

Fig. 16

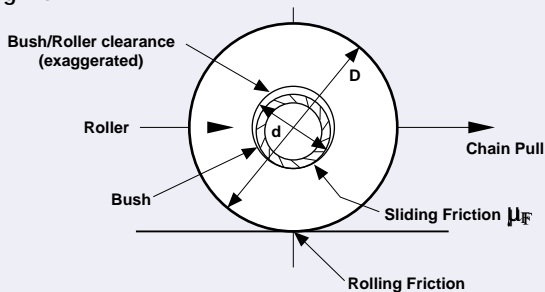

Thus the overall theoretical coefficient of chain rollers moving on a rolled steel track =

$$\frac{0.26 + (\mu_F \times \text{Roller bore (mm)})}{\text{Roller diameter (mm)}}$$

In practice, a contingency is allowed, to account for variations in the surface quality of the tracking and other imperfections such as track joints. The need for this is more evident as roller diameters become smaller, and therefore the roller diameter is used in an additional part of the formula, which becomes:

$$\text{Overall coefficient of friction} = \mu_c = \frac{0.26 + (\mu_F \times d)}{D} + \frac{1.64}{D}$$

$$\text{and simplified: } \mu_c = \frac{1.90 + \mu_F d}{D}$$

- Where  $\mu_c$  = overall coefficient of friction for chain.
- $\mu_F$  = bush/roller sliding friction coefficient.
- d = roller bore diameter in mm.
- D = roller outside diameter in mm.

The formula is applicable to any plain bearing roller but in the case of a roller having ball, roller or needle bearings the mean diameter of the balls etc. (Bd), would be used as the roller bore.  $\mu_F$  is taken as 0.0025 to 0.005, the latter being assumed to apply to most conditions. Thus overall coefficient of friction for a chain roller fitted with ball bearings and rolling on a steel track:

$$\mu_c = \frac{0.26 + (0.005 \times \text{Mean diameter of balls (mm)})}{\text{Roller diameter (mm)}} + \frac{1.64}{\text{Roller diameter (mm)}}$$

$$\therefore \mu_c = \frac{1.90 + (0.005 \times Bd)}{D}$$

Fig. 17

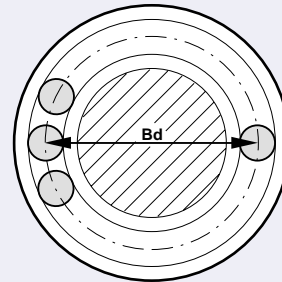

The following table shows values for overall coefficient of friction for standard conveyor chain with standard rollers ( $\mu_c$ ). Alternative values can be calculated as above if the roller diameter is modified from the standard shown.

#### OVERALL COEFFICIENTS OF ROLLING FRICTION FOR STANDARD CONVEYOR CHAIN ( $\mu_c$ )

Table 2

Chain Reference	Ultimate Strength (kN)	Roller Diameter (mm) D	Chain Overall Coefficient of Friction $\mu_c$		
			Regular Lubrication $\mu_F = 0.15$	Occasional Lubrication $\mu_F = 0.20$	No Lubrication $\mu_F = 0.25$
<b>BS Series</b>					
BS13	13	25.4	0.13	0.14	0.16
BS20	20	25.4	0.15	0.17	0.19
BS27/BS33	27/33	31.8	0.15	0.18	0.20
BS54/BS67	54/67	47.6	0.12	0.14	0.17
BS107/BS134	107/134	66.7	0.10	0.13	0.15
BS160/BS200	160/200	88.9	0.09	0.11	0.13
BS267	267	88.9	0.09	0.11	0.13
BS400	400	88.9	0.09	0.11	0.13
<b>ISO Series</b>					
M40	40	36	0.11	0.12	0.14
M56	56	42	0.10	0.12	0.14
MC56	56	50	0.10	0.12	0.14
M80	80	50	0.09	0.11	0.13
M112	112	60	0.09	0.10	0.12
MC112	112	70	0.09	0.11	0.13
M160	160	70	0.08	0.10	0.12
M224	224	85	0.08	0.09	0.11
MC224	224	100	0.08	0.10	0.12
M315	315	100	0.07	0.09	0.11
M450	450	120	0.07	0.09	0.10
M630	630	140	0.07	0.09	0.10
M900	900	170	0.06	0.08	0.10

### ROLLER SELECTION AND ROLLER LOADING CONSIDERATIONS

#### Roller Selection

##### Roller Materials

1. Unhardened mild steel rollers are used in lightly loaded, clean and well lubricated applications subject to occasional use.
2. Hardened steel rollers are used in the majority of applications where a hard wearing surface is required. Note that through hardened sintered rollers are standard on BS chain of 26 to 67KN breaking load. On all other BS and on ISO chain the standard hardened rollers are in case hardened mild steel.
3. Cast iron rollers are used in applications where some corrosion is likely and a measure of self-lubrication is required.
4. Synthetic rollers, e.g. Delrin, nylon or other plastics can be used where either noise or corrosion is a major problem. Please enquire.

#### Roller Sizes and Types

1. Small (gearing) rollers are used for sprocket gearing purposes only to reduce abrasion and wear between chain bush and sprocket tooth. These rollers do not project and consequently, when not operating vertically, the chain will slide on the side plate edges.
2. Standard projecting rollers are used for most conveying applications and are designed to operate smoothly with optimum rolling friction properties. They create an acceptable rolling clearance above and below the chain side plates.
3. Flanged rollers are used where extra guidance is required or where imposed side loads would otherwise force the chain out of line.
4. Larger diameter rollers are occasionally used where the greater diameter of the roller reduces wear by reducing the rubbing velocity on the chain bushes and promotes smoother running at slow speeds. These rollers can be either plain or flanged in steel, cast iron or synthetic material.
5. Most chain can be supplied with ball bearing rollers either outboard or integral. This special design option can be justified by the selection of a lower breaking load chain in many applications and a reduction in the drive power required.

#### Roller Loading (Bush/Roller Wear)

In the majority of cases a conveyor roller chain will meet bush/roller wear requirements if it has been correctly selected using factors of safety on breaking load. Doubt can arise where heavy unit loading is involved, which could cause the bearing pressure between the chain bush and roller to be excessively high, or where the chain speed may exceed the recommended maximum. In such cases further checks have to be made.

#### Bush/Roller Bearing Areas and Bearing Pressures

The bush/roller bearing areas for standard BS and ISO series conveyor chain are as follows:

##### Bush/Roller Bearing Area – BS

Chain Reference	Bearing Area mm <sup>2</sup>
BS13	99
BS20	143
BS27	254
BS33	254
BS54	420
BS67	420
BS107	803
BS134	803
BS160	1403
BS200	1403
BS267	1403
BS400	1403

Table 3

##### Bush/Roller Bearing Area - ISO

Chain Reference	Bearing Area mm <sup>2</sup>
M40	232
M56	333
MC56	447
M80	475
M112	630
MC112	850
M160	880
M224	1218
MC224	1583
M315	1634
M450	2234
M630	3145
M900	4410

Table 3 (Continued)

#### Bearing Pressure

Normal maximum permitted bearing pressures for chain speeds up to 0.5m/sec., and in reasonably clean and lubricated applications are listed below:

Roller Material	Bearing Pressure P Normal Maximum
Mild steel case hardened	1.8N/mm <sup>2</sup>
Sintered steel through hardened	1.2N/mm <sup>2</sup>
Cast iron	0.68N/mm <sup>2</sup>

Table 4

The formula: bearing pressure P (N/mm<sup>2</sup>) =  $\frac{\text{roller load R (N)}}{\text{Bearing area BA (mm}^2\text{)}}$

is used first to check whether actual pressure exceeds the above recommendation. If it does, or if the conveyor speed exceeds 0.5m/sec, the chain may still be acceptable if alternative conditions can be met. These depend upon a combination of bearing pressure and rubbing speed between bush and roller, known as the PV<sub>R</sub> value, and the degree of cleanliness and lubrication on the application. If cleanliness and lubrication are much better than average for example, higher bearing pressures and PV<sub>R</sub> values than normal can be tolerated. In order to make this judgement the following table is used, along with the formula:



Rubbing Speed  $V_R$  (m/sec) =

$$\frac{\text{Chain Speed (m/sec)} \times \text{Bush diameter (mm)}}{\text{Roller Diameter (mm)}}$$

**Table 5**

Roller Material	Rubbing speed $V_R$ (m/sec)		Max. Bearing Pressure $P$ (N/mm <sup>2</sup> )	
	Very Good Conditions	Average Conditions	Very Good Conditions	Average Conditions
Case hardened mild steel	0.025 - 0.15 over 0.15	0.025 - 0.25 over 0.25	10.35 use $PV_R = 1.55$	1.80 use $PV_R = 0.45$
Sintered through-hardened steel	0.025 - 0.15 over 0.15	0.025 - 0.25 over 0.25	6.90 use $PV_R = 1.04$	1.20 use $PV_R = 0.30$
Cast iron	0.025 - 0.15 over 0.15	0.025 - 0.25 over 0.25	3.91 use $PV_R = 0.59$	0.68 use $PV_R = 0.17$

If the rubbing speed is above 0.15 m/s, calculate the PV value to see if it is below the max value in the table. If the rubbing speed is below 0.15 calculate the bearing pressure to see if it is below the maximum given in the table. If the speed is below 0.025 m/s it is best to use rollers with an o/d to bore ratio of 3 or higher, or use ball bearing inboard or outboard rollers with the required load capacity.

If the calculated bearing pressure or PV exceeds the guidelines given in the tables then consider one of the following:

- Use a larger chain size with consequently larger rollers.
- Use larger diameter rollers to reduce the rubbing speed.
- Use outboard rollers, either plain or ball bearing.
- Use ball bearing rollers.
- If in doubt consult Renold.

**Fig. 18**

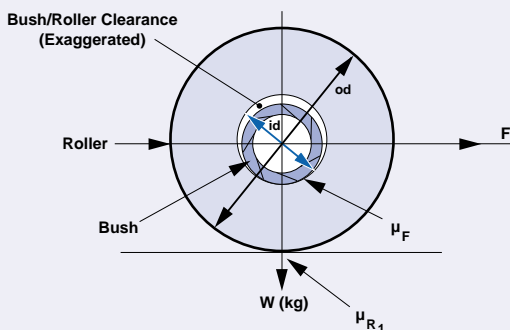

### 'STICK-SLIP'

'Stick-Slip' is a problem that occurs in some slow moving conveyor systems which results in irregular motion of the chain in the form of a pulse. Stick slip only occurs under certain conditions and the purpose of this section is to highlight those conditions to enable the problem to be recognised and avoided. For a conveyor running at a linear speed of approx. 0.035m/sec or less, one of the most often encountered causes of stick-slip is over-lubrication of the chain. Too much oil on the chain leads to the chain support tracks being coated with oil thus lowering  $\mu_{R1}$ , (Fig. 18). If any of the other stick-slip conditions are present then  $\mu_{R1}$  is insufficient to cause the roller to turn against the roller/bush friction  $\mu_F$  and the roller slides along on a film of oil.

The oil film builds up between the bush and roller at the leading edge of the pressure contact area and the resulting vacuum condition between the two surfaces requires force to break it down. If the chain tracks are coated with oil, or oil residue, then this force is not immediately available and the roller slides along the track without rotating. The vacuum then fails, either due to the static condition of the bush/roller surfaces or by the breakdown of the dynamic film of lubricant on the track.

In either case the change from the sliding state to rotation causes a pulse as the velocity of the chain decreases and then increases.

Once rotation returns then the cycle is repeated causing regular pulsations and variations of chain speed. Although the friction is insufficient to cause the roller to turn, friction is present and, over a period, the roller will develop a series of flats which will compound the problem.

The other features that are necessary for stick slip to occur are:

- Light loading - If the loading on the roller is very light then it is easy for a vacuum condition to develop. Heavy loads tend to break the oil film down on the chain tracks.
- Irregular loading - If the chain is loaded at intervals, with unloaded gaps, it is possible for the chain between the loads to experience stick slip due to light loading.

### Precautions to Avoid Stick Slip

- Avoid speeds in the critical range up to approx. 0.035m/sec., if possible.
- Avoid irregular loading, if possible.
- If it is not possible to avoid the speed and loading criticality, then great care should be taken in system design:
  - Control the application of lubricant to avoid track contamination.
  - If light loads are to be carried then chain rollers should be either larger than standard or be fitted with ball bearings to lower the bush/roller friction,  $\mu_F$ , or improve mechanical efficiency.

As a rough guide, where plain (not ball bearing) rollers are used, a ratio of roller diameter to bush diameter of 2.7:1 or greater should eliminate stick slip at the critical speeds.

## TRACKED BENDS

Where chain is guided around curves there is an inward reaction pressure acting in the direction of the curve centre. This applies whether the curved tracks are in the vertical or horizontal planes, and, relative to the former, whether upwards or downwards in direction. The load pull effect resulting from the chain transversing a curved section, even if this be in the vertical downward direction, is always considered as a positive value, i.e. serving to increase the chain load pull.

An analogy is a belt on a pulley whereby the holding or retaining effect depends upon the extent of wrap-around of the belt, and friction between the belt and pulley.

Similarly there is a definite relationship between the tension or pull in the chain at entry and exit of the curve. Referring to the diagrams this relationship is given by:

$$P_2 = P_1 e^{\mu_c \theta}$$

Where  $P_1$  = Chain pull at entry into bend (N)

$P_2$  = Chain pull at exit from bend (N)

$e$  = Napierian logarithm base (2.718)

$\mu_c$  = Coefficient of friction between chain and track

$\theta$  = Bend angle (radians)

Fig. 19

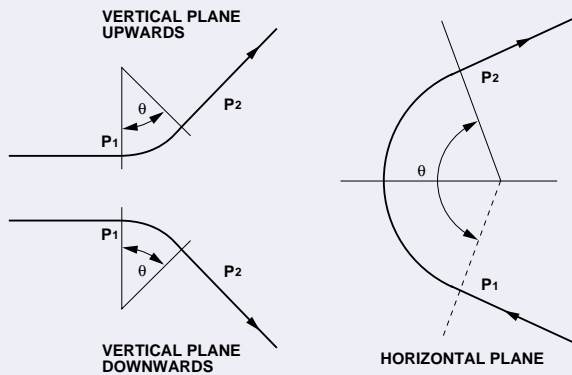

The above formula applies whether the chain is tracked via the chain rollers or by the chain plate edges bearing on suitable guide tracks. Table 6 gives values of  $e^{\mu c \theta}$ .

Table 6

Values of $e^{\mu c \theta}$ for variable Values of $\mu c \theta$					
$\mu c \theta$	$e^{\mu c \theta}$	$\mu c \theta$	$e^{\mu c \theta}$	$\mu c \theta$	$e^{\mu c \theta}$
0.02	1.0202	0.25	1.2840	0.45	1.5683
0.04	1.0408	0.26	1.2969	0.46	1.5841
0.06	1.0618	0.27	1.3100	0.47	1.6000
0.08	1.0833	0.28	1.3231	0.48	1.6161
		0.29	1.3364	0.49	1.6323
0.10	1.1052	0.30	1.3499	0.50	1.6487
0.11	1.1163	0.31	1.3634	0.56	1.8221
0.12	1.1275	0.32	1.3771	0.57	2.0138
0.13	1.1388	0.33	1.3910	0.58	2.2255
0.14	1.1505	0.34	1.4050	0.59	2.4596
0.15	1.1618	0.35	1.4191	1.0	2.7183
0.16	1.1735	0.36	1.4333	1.1	3.0042
0.17	1.1835	0.37	1.4477	1.2	3.3201
0.18	1.1972	0.38	1.4623	1.3	3.6693
0.19	1.2092	0.39	1.4770	1.4	4.0552
0.20	1.2214	0.40	1.4918	1.5	4.4817
0.21	1.2337	0.41	1.5068	1.6	4.9530
0.22	1.2461	0.42	1.5220	1.7	5.4739
0.23	1.2586	0.43	1.5373	1.8	6.0497
0.24	1.2712	0.44	1.5527	1.9	6.6859
				2.0	7.3891

Since high reaction loadings can be involved when negotiating bend sections it is usually advisable to check the resulting roller loading. This can be done from the following formula where  $R_i$  is the load per roller due to the reaction loading at the bend section.

$$R_i(N) = \frac{P_2(N) \times \text{Chain Pitch (mm)}}{\text{Chain curve radius (mm)}}$$

The reaction loading value obtained should then be added to the normal roller load and the total can be compared with the permitted values discussed in the section on roller selection and roller loading considerations.

### MINIMUM TRACK RADIUS FOR LINK CLEARANCE

There is a minimum radius which a chain can negotiate without fouling of the link plate edges. Relevant minimum radii against each chain series are listed in table 7 on page 76, and it will be noted that these will vary according to pitch, roller diameter and plate depth.

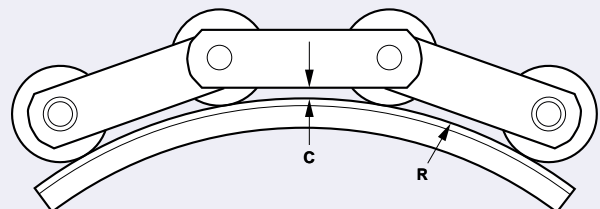

## Minimum Track Radii for BS and ISO Series Chain

Table 7

BS SERIES Chain Ref.	Roller Dia. mm	Clearance C mm	Pitch mm	Track Radius R mm
BS13	25.4	1.3	38.10	60
			50.80	115
			63.50	190
			76.20	280
			88.90	380
			101.60	500
BS20	25.4	1.3	114.30	635
			38.10	90
			50.80	160
			63.50	255
BS27 BS33	31.8	1.3	76.20	375
			88.90	510
			101.60	670
			114.30	845
			127.00	1050
			139.70	1270
BS54 BS67	47.6	2.5	152.40	1500
			177.80	1755
			203.20	2300
			228.60	2920
			76.20	305
			88.90	425
			101.60	560
			114.30	720
			127.00	890
			152.40	1295
BS107 BS134	66.7	4	177.80	970
			203.20	1280
			228.60	1630
			254.00	2020
			304.80	2920
			101.60	295
			127.00	480
			152.40	710
			165.10	830
BS160 BS200 BS267	88.9	5	177.80	400
			203.20	540
			228.60	690
			254.00	860
			304.80	1250
			381.00	1980
			457.20	2870
			127.00	185
BS400	88.9	5	152.40	335
			228.60	810
			304.80	1470
			381.00	2320
			457.20	3350
			609.60	5990
			228.60	810

ISO SERIES Chain Ref.	Roller Dia. mm	Clearance C mm	Pitch mm	Track Radius R mm
M40	36	1.3	63	136
			80	218
			100	340
			125	530
			160	867
M56	50	2.5	63	77
			80	138
			100	228
			125	368
			160	618
			200	978
MC56 M80	50	2.5	250	1540
			80	163
			100	253
			125	393
			160	643
M112	60	4	200	1003
			250	1565
			80	106
			125	299
			160	506
			200	806
MC112 M160	70	4	250	1275
			315	2040
			400	3306
			100	182
			125	283
M224	85	5	160	461
			200	718
			250	1120
			315	1775
			125	222
			160	388
MC224 M315	100	5	200	628
			250	1003
			315	1615
			400	2628
			500	4128
			630	6576
			160	593
M450	120	6	200	953
			250	1515
			315	2433
			400	3953
			500	6202
			630	9875
			200	304
			250	505
M630	140	7	315	833
			400	1376
			500	2179
			630	3491
			800	5661
			250	537
M900	170	8	315	891
			400	1475
			500	2340
			630	3753
			800	6090
			1000	9552
			315	653
M450	120	6	400	1100
			500	1762
			630	2842
			800	4629
			1000	7276
			200	304

## MATCHING OF CONVEYOR CHAIN

Any application in which two or more strands of chain are required to operate side by side may require the strands to be matched. This would be to maintain the same fixed relationship between handling lengths throughout the length of the chains.

Due to manufacturing tolerances on chain components actual chain length may vary within certain limits. Thus, two strands of any given pitch length would not necessarily have the same actual overall length if chosen at random. Also, different sections along any chain length may vary within the permissible limits and therefore, even given identical overall lengths, corresponding sections of random strands would be slightly out of register. These displacements tend to become more pronounced with increasing length.

## CONVEYOR TYPES

The types of conveyors where this is likely to have the greatest effect are:

- 1) Where chains are very close and tied together, i.e. within approximately 300/500mm depending on breaking load.
- 2) On very long or long and complex circuits.
- 3) Where load positioning / orientation at load or unload is important.

## PROCEDURE

The procedure used for matching conveyor chain is as follows:-

- a) Each handling length is accurately measured and numbered.
- b) A list is produced (for a two chain system) of chains, e.g A and B, in which handling lengths placed opposite each other are as near equal in length as possible.
- c) This list will give a series of lengths in which A and B are matched, A<sub>1</sub> with B<sub>1</sub>, A<sub>2</sub> with B<sub>2</sub>, etc.
- d) The chains are then tagged with a brass tag containing the appropriate identity, i.e. A<sub>2</sub> B<sub>4</sub> etc and, where required, the chain length.

## ON-SITE ASSEMBLY

When assembling the chain on site it is important that lengths A and B are installed opposite each other as are A<sub>1</sub>, and B<sub>1</sub>, etc.

## ATTACHMENTS

It should be noted that chains can only be matched as regards the chain pitch length. Due to extra tolerances involved in attachment positioning and holing it is not possible to match chains relative to attachments.

## SPROCKETS

Where chains have been matched, the drive sprockets should not only be bored and keywayed as a set in relation to a tooth, as in a normal conveyor drive, but it is recommended that a machine cut tooth form is also used to ensure equal load sharing.

## ACCURACY

In order to maintain the accuracy of matched chains it is important to ensure equal tensioning and even lubrication of the chain set.

### PUSHER CONVEYORS

Where chain is used with pusher attachment plates, to move loads along a separate skid rail (e.g. billet transfer conveyors), then there will be an extra load in the chain due to the reaction in the pushers.

This load can be calculated by the following formula:

$$P_L = \mu_m W \frac{h_u \mu_c}{P}$$

- Where
- $\mu_m$  = Coefficient Friction, Load on Steel
  - $\mu_c$  = Coefficient Friction, Chain Rolling
  - $W$  = Load (N)
  - $h_u$  = Pusher Height from Chain Pitch Line (mm)
  - $P$  = Chain Pitch (mm)

If there is more than one pusher and load position then the total reaction load can be found by either multiplying by the total number of loads or by assuming that the total load acts at one pusher.

This reaction load pull should then be added to the total chain pull  $C_p$  obtained using layout B page 80 and ignoring the term X (side guide friction).

Fig. 20

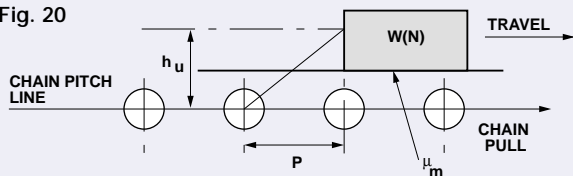

### CONVEYING DIRECTLY ON CHAIN ROLLERS

In some applications, loads are carried directly on the projecting rollers of the chain, instead of on attachments connected to the chain side plates. In this case the loads will travel at twice the speed of the chain.

Where high unit loads are involved the rollers must be either case hardened mild steel or through hardened medium carbon steel. For normal duty the tracks can be standard rolled sections but for heavy unit loads hardened tracks may be necessary.

**Note:** The roller hardness should always be greater than track hardness.

Fig. 21

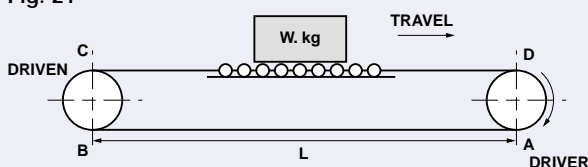

$$C_p = 9.81 \left[ \frac{W \times (2\mu_{R1} + 2\mu_{R3} + 1.64)}{D} \times (1 + \mu_c) \right] + (2.05 \times W_c \times L \times \mu_c) \text{ N}$$

For a layout similar to the above, the chain pull can be calculated as follows:

- Where
- $C_p$  = Total chain pull (N)
  - $W$  = Weight of material on conveyor (kg)
  - $W_c$  = Weight of chain(s) and attachments (kg/m)
  - $L$  = Conveyor centres (m)
  - $\mu_{R1}$  = Coefficient of rolling friction between chain roller and track
  - $\mu_{R3}$  = Coefficient of rolling friction between chain roller and load
  - $\mu_c$  = Chain overall coefficient of friction
  - $d$  = Roller I/D (mm)
  - $D$  = Roller O/D (mm)

Fig. 22

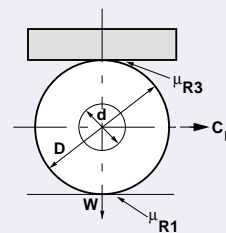

Rolling friction  $\mu_{R1}$  for a steel roller on a rolled or pressed steel track is variable between 0.051 and 0.13 depending on the track surface condition.

The rolling friction between the roller and the load is also variable depending upon the latter. For many applications it is sufficiently accurate to take  $\mu_{R3}$  as being 0.13.

### SIDE FRICTION FACTORS

It must be appreciated that on apron conveyors carrying loose materials, and where static skirt plates are employed, the pressure of material sliding against the skirt will increase the required load pull of the chain.

Fig. 22

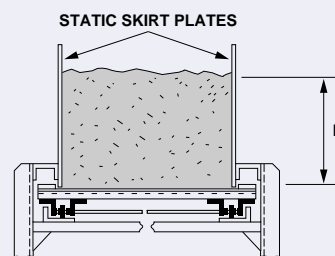

This additional pull is given by the expression:

$$2.25 \times 10^4 GLH^2 \text{ (N)}$$

- Where
- $H$  = the height of the material (m)
  - $L$  = the length of the loaded section of conveyor (m)
  - $G$  = a factor depending upon the material being handled. - See page 79 table 8.

Table 8

Material	Factor G (Side Friction)	μm
Ashes, dry, 13mm and under	0.05	0.50
Ashes, wet, 13mm and under	0.02	0.60
Ashes, wet, 75mm and under	0.02	0.60
Cement, Portland	0.09	0.70
Cement, clinker	0.08	0.70
Coal, Anthracite, nuts	0.04	0.50
Coal, Bituminous, slack, wet	0.03	0.70
Coke, sized 13mm	0.02	0.40
Coke, breeze, fine	0.03	0.70
Grain	0.05	0.40
Gravel, dry, screened	0.08	0.50
Lime, ground	0.04	0.40
Lime, pebble	0.07	0.50
Limestone, crushed	0.14	0.90
Sand, dry	0.13	0.60
Sand, damp	0.17	0.90
Sand, foundry, prepared	0.07	0.90
Sawdust	0.01	0.40
Stone, dust	0.09	0.50
Stone, lumps and fines	0.10	0.70
Soda ash (heavy)	0.09	0.62
Sodium carbonate	0.04	0.45
Wood, chips	0.01	0.40

Values given are nominal and are for guidance only; they are based on the materials sliding on steel.

### METHODS OF SELECTION

- Examine the diagrams A to K (page 80-81) and select the layout nearest to the conveyor under consideration.
- Examine the formulae printed under the selected layout for the conveyor chain pull (Cp).
- Identify and allocate values to the elements of the formulae by using the reference list opposite.
- Calculate a preliminary chain pull using an estimated chain mass.
- Apply the correct factor of safety for the application from Table 1 page 71. If temperature and type of application affect your selection, then select the highest factor from other relevant sections.  
  
Chain breaking load = Chain Pull Cp x factor of safety.
- For the chain breaking strength established in the preliminary calculation, recalculate maximum chain pull Cp using actual chain mass and check the factor of safety obtained.
- If loads are carried by the chain, then the roller capacity should be checked - page 73.

- Conveyor headshaft power may be calculated by using the appropriate formula for K which will give the results in Kilowatts.

**Note:** The power calculated is that required to keep the conveyor moving, not the motor size required. To select a motor, allowance should be made for starting and transmission losses.

- Headshaft RPM can be calculated after selecting a suitable size of drive sprocket.

$$RPM = \frac{V \times 60}{PCD \times \pi}$$

where PCD = Pitch circle dia. of sprocket (m).

- Headshaft torque can be calculated as follows:

$$Torque = \frac{Cp \times PCD}{2} \text{ (Nm)}$$

### REFERENCE LIST

- Cp = Chain pull total (N)
- L = Centre distance (m) - head- to tail-shaft
- Wc = Chain total mass per metre (kg/m) including attachments and fittings.
- Wm = Mass of load/metre (kg/m)
- W = Total carried load (kg)
- T = Conveying capacity (Tonnes/Hour)
- V = Chain speed (m/sec)
- μc = Coefficient of friction, chain on steel (sliding or rolling) - see Table 2 page 72.
- μm = Coefficient of friction, load on steel. See table 8 opposite.
- ρ = Load density (kg/m<sup>3</sup>)
- α = Angle of inclination (degrees).
- G = Side friction factor. See table 8 opposite.
- C = Conveyor width (m)
- H = Material height (m)
- S = Bucket spacing (m)
- Vb = Bucket capacity (m<sup>3</sup>)
- K = Power at headshaft (kW)
- Wb = Bucket mass (kg)
- X = Extra chain pull due to side guide friction  
[X = 2.25 x 10<sup>4</sup> GLH<sup>2</sup> (N) - See page 78]
- P<sub>B</sub> = Chain pull at B (N).
- μs1 = (μc x cos α) - sin α } see appendix 3 page 104-105
- μs2 = (μc x cos α) + sin α }
- μsm = (μm x cos α) + sin α
- Df = Dredge factor (spaced bkts)(N) =  $\frac{90 \times Vb \times \rho}{S}$
- Dredge factor (continuous bkts)(N) =  $\frac{30 \times Vb \times \rho}{S}$
- J = Chain sag (m)
- a = Idler centres (m)

**NOTE:**

m = Metres, N = Newtons, kW = Kilowatts, kg = Kilograms.

**LAYOUT A**  
Chain and material sliding

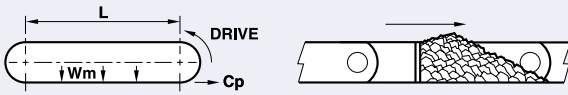

$$C_p = 9.81 \times L [(2.05 \times W_c \times \mu_c) + (W_m \times \mu_m)] + X \text{ (N)}$$

$$K = \frac{C_p \times V}{1000} \text{ (kW)}$$

**LAYOUT B**  
Chain rolling and material sliding

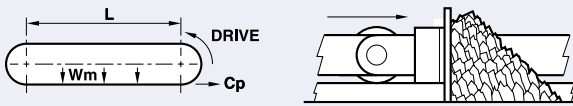

$$C_p = 9.81 \times L [(2.05 \times W_c \times \mu_c) + (W_m \times \mu_m)] + X \text{ (N)}$$

$$K = \frac{C_p \times V}{1000} \text{ (kW)}$$

**LAYOUT C**  
Chain rolling and material carried



$$C_p = 9.81 \times \mu_c [(2.05 \times W_c \times L) + W] \text{ (N)}$$

$$K = \frac{C_p \times V}{1000} \text{ (kW)}$$

**LAYOUT D**  
Chain sliding and material carried



$$C_p = 9.81 \times \mu_c [(2.05 \times W_c \times L) + W] \text{ (N)}$$

$$K = \frac{C_p \times V}{1000} \text{ (kW)}$$

**LAYOUT E**  
Chain and material sliding

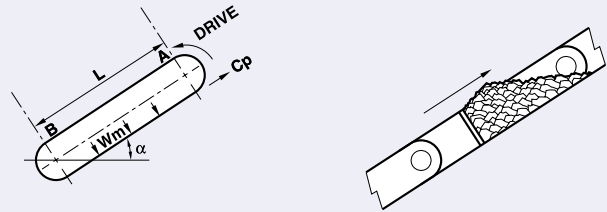

$$P_B = 9.81 \times W_c \times L \times \mu_{s1} \text{ (N)}$$

$$C_p = 9.81 \times L [(W_c \times \mu_{s2}) + (W_m \times \mu_{sm})] + P_B + X \text{ (N)}$$

$$K = \frac{C_p \times V}{1000} \text{ (kW)}$$

**LAYOUT F**  
Chain rolling and material sliding

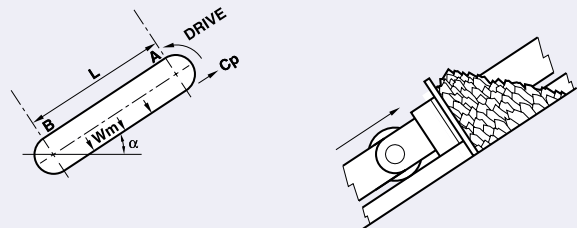

$$P_B = 9.81 \times W_c \times L \times \mu_{s1} \text{ (N)}$$

$$C_p = 9.81 \times L [(W_c \times \mu_{s2}) + (W_m \times \mu_{sm})] + P_B + X \text{ (N)}$$

$$K = \frac{C_p \times V}{1000} \text{ (kW)}$$

**LAYOUT G**  
Chain rolling and material carried

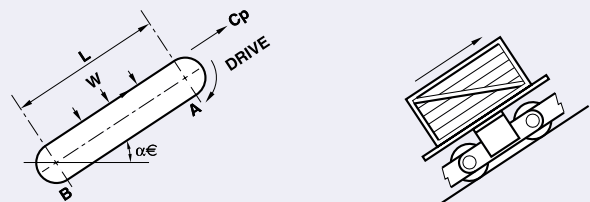

$$P_B = 9.81 \times W_c \times L \times \mu_{s1} \text{ (N)}$$

$$C_p = 9.81 \times \mu_{s2} [(W_c \times L) + W] + P_B \text{ (N)}$$

$$K = \frac{C_p \times V}{1000} \text{ (kW)}$$

**LAYOUT H**  
Vertical elevator

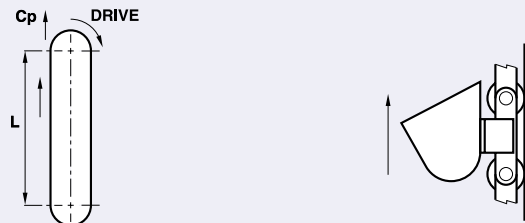

$$C_p = 9.81 \left[ \frac{(w_b \times L)}{S} + (W_c \times L) + \frac{(L \times V_b \times p)}{S} \right] + D_f \text{ (N)}$$

$$K = \frac{[(9.81 \times \frac{(L \times V_b \times p)}{S}) + D_f] \times V}{1000} \text{ (kW)}$$

### LAYOUT J

Chain rolling, material carried. Return strand unsupported.

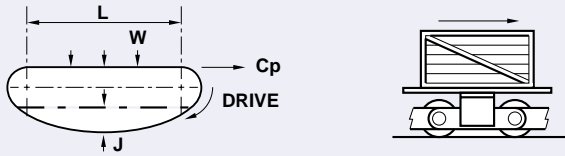

$$C_p = 9.81 \left[ 1.05 \left( \frac{L^2 \times Wc}{8 \times J} + (Wc \times J) \right) + (\mu_c \times Wc \times L) + (\mu_c \times W) \right] \text{ (N)}$$

$$K = 9.81 \left[ 0.05 \left( \frac{L^2 \times Wc}{8 \times J} + (Wc \times J) \right) + (\mu_c \times Wc \times L) + (\mu_c \times W) \right] \times \frac{V}{1000} \text{ (kW)}$$

### LAYOUT K

Chain rolling, material carried. Return strand on idlers.

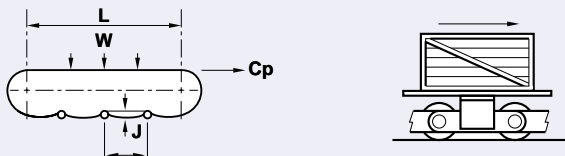

$$C_p = 9.81 \left[ 1.05 \times \frac{L}{a} \left( \frac{a^2 \times Wc}{8 \times J} + (Wc \times J) \right) + (\mu_c \times Wc \times L) + (\mu_c \times W) \right] \text{ (N)}$$

$$K = 9.81 \left[ 0.05 \times \frac{L}{a} \left( \frac{a^2 \times Wc}{8 \times J} + (Wc \times J) \right) + (\mu_c \times Wc \times L) + (\mu_c \times W) \right] \times \frac{V}{1000} \text{ (kW)}$$

## SELECTION EXAMPLE

A continuous slat conveyor, 36 metre centres of head and tail sprockets, is to carry boxed products 650mm x 800mm, of mass 36kg each. 50 boxes will be the maximum load and two chains are required with K attachments at every pitch one side. 152.4mm pitch chain is preferred and the mass of the slats is 15kg/m. Operating conditions are clean and well lubricated. Chain speed would be 0.45 m/sec using 8 tooth sprockets.

The example is of chain rolling and material carried, i.e. Layout C, page 80

It is first necessary to carry out a preliminary calculation to arrive at a chain size on which to base the final calculation. A rough assessment of chain mass can be done by doubling the slat mass, and for rolling friction a figure of 0.15 can be used.

Mass of Load on Conveyor = 50 x 36 = 1800 kg  
 Mass per Metre of Slats = 15 kg/m  
 Estimated Mass of Chain = 15 kg/m  
 Estimated Mass of Chain & Slats = 15 + 15 = 30 kg/m  
 Preliminary Chain Pull = 9.81 x  $\mu_c$  [(2.05 x Wc x L) + W] N  
 = 9.81 x 0.15 [(2.05 x 30 x 36) + 1800] N  
 = 5907 N

Factor of safety for this application is 8 (from table 1 page 71).

∴ Minimum Breaking Load Required =  $\frac{5907 \times 8}{2}$  per chain = 23628 N

As a solid bearing pin chain is preferable for this application then two strands of 152.4 mm pitch BS series, 33000 N (7500 lbf) breaking load chain may be suitable.

### Final Calculation

Chain mass + K3 integral attachment one side every pitch = 3.35 kg/m (from chain catalogue)

Mass of Both Chains = 3.35 x 2 = 6.7 kg/m

Mass of Chain + Slats = 6.7 + 15 = 21.7 kg/m

$\mu_c$  = 0.15 - taken from table 2 page 72. (Regular lubrication).

Cp (Chain pull) = 9.81 x  $\mu_c$  [(2.05 x Wc x L) + W] N

Cp = 9.81 x 0.15 [(2.05 x 21.7 x 36) + 1800] N

Cp = 5005 N

Factor of Safety =  $\frac{\text{Breaking load} \times 2}{\text{Total chain pull}} = \frac{33000 \times 2}{5005} = 13.19$

Thus the selection is confirmed.

It is now necessary to check the roller loading.

Box = 650 mm long. Load = mass x g (gravity) = 36 x 9.81 = 353 N

Load of Chain and Slats over 650 mm = 21.7 x 9.81 x .65 = 138 N

Total Load on Rollers = 353 + 138 = 491 N

Number of Rollers Supporting Load =  $\frac{650 \times 2}{152.4} = 8.5$

Load Per Roller =  $\frac{491}{8.5} = 58$  N

Bearing Area of Roller (see table 3) = 254 mm<sup>2</sup>

∴ Bearing Pressure of Rollers =  $\frac{58}{254} = 0.23$  N/mm<sup>2</sup>

This is well below the allowable maximum of 1.2 N/mm<sup>2</sup> (see page 73 table 4 sintered steel) therefore the roller loading is acceptable.

### Conclusion

The selection for this application would be 2 strands of 152.4 mm pitch, 33,000N (7500lbf) breaking load BS series chain with standard sintered steel rollers (Chain No. 145240/16) and K3 bent over attachments one side every pitch.

Power required to drive the conveyor would be:

$$K = \frac{\text{Chain pull} \times \text{Chain speed}}{1000} = \frac{C_p \times V}{1000} \text{ kW}$$

$$= \frac{5005 \times 0.45}{1000} = 2.25 \text{ kW}$$

**Note:** This is the power required at the headshaft to keep the conveyor moving, not the motor size required. Allowance should be made for starting and transmission/gearing losses when selecting a drive motor.

Headshaft RPM required using an 8 tooth (398.2 mm PCD) sprocket would be

$$\text{RPM} = \frac{\text{Chain Speed (m/sec)} \times 60}{\text{PCD (m)} \times \pi}$$

$$= \frac{0.45 \times 60}{0.398 \times \pi} = 21.6 \text{ RPM}$$

$$\text{Headshaft Torque} = \frac{C_p \times \text{PCD}}{2} \text{ Nm}$$

$$= \frac{5005 \times 0.398}{2} = 996 \text{ Nm}$$



### CALCULATING COMPLEX CIRCUITS

For calculating chain pull  $C_p$  of complex circuits, which do not conform to one of the layouts A to K (page 80), the following method can be used as a guide, or Renold Applications Department may be contacted.

Fig. 24 Sideview of conveyor circuit

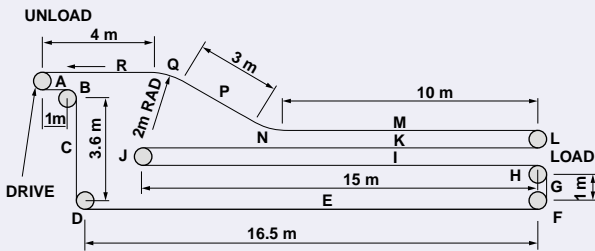

On the circuit shown in fig. 24, loads are suspended from staybars at 304.8 mm (12") spacing and carried by two chains. Each staybar carries 20 kg load. The loads are put on the conveyor at position H and unloaded at the drive point. Chain speed is 0.067 m/sec (13.2 ft/min). A 152.4 mm (6") pitch chain is to be used running on 12 tooth sprockets to ensure adequate clearance of the loads at each turn.

The chains are spaced at 1.5m centres and each staybar has a mass of 3 kg. On all horizontal and inclined sections the chain is supported on tracks and runs on its rollers. Assume occasional lubrication.

To calculate the maximum chain pull it is first necessary to estimate a chain mass. This can be either an educated guess, or a typical chain mass from the Renold catalogue, or by using a guideline such as the staybar (attachment) mass. For this example we will use the staybar mass.

$$\begin{aligned} \text{Mass of staybars} &= 3 \text{ kg at } 304.8\text{mm spacing} \\ &= \frac{3 \times 1000 \text{ kg/m}}{304.8} \\ &= 9.84 \text{ kg/m} \end{aligned}$$

$$\begin{aligned} \text{Total estimated mass of chain + staybars} \\ W_c &= 9.84 + 9.84 = 19.68 \text{ kg/m} \end{aligned}$$

$$\begin{aligned} \text{Mass of load} \\ W_m &= 20 \text{ kg at } 304.8 \text{ mm spacing} \end{aligned}$$

$$\text{Mass of load per metre} = \frac{20 \times 1000}{304.8} = 65.62 \text{ kg/m}$$

For initial calculation assume coefficient of friction  $\mu_c = 0.15$

$$\begin{aligned} \therefore \mu_{s1} &= (\mu_c \times \cos 30^\circ) - \sin 30^\circ \\ &= (0.15 \times 0.866) - 0.5 \\ &= -0.37 \end{aligned}$$

$$\begin{aligned} \therefore \mu_{s2} &= (\mu_c \times \cos 30^\circ) + \sin 30^\circ \\ &= (0.15 \times 0.866) + 0.5 \\ &= 0.63 \end{aligned}$$

At the bend sections it is necessary to establish the bend factor  $e^{\mu_c \theta}$ .

$$\mu_c = 0.15$$

$$\theta = 30^\circ \text{ i.e. } 0.524 \text{ radians}$$

$$\therefore \mu_c \theta = 0.15 \times 0.524 = 0.0786$$

$$\therefore e^{\mu_c \theta} = 1.082$$

To establish the total chain pull it is necessary to break the circuit into convenient sections as in fig. 24, i.e. A to R. Chain pull in these sections can be calculated separately and the values added together starting at the point of lowest tension which is immediately after the drive sprocket.

Each type of section can be calculated as follows:-

$$\begin{aligned} \text{Vertically upward} \\ \text{Pull} &= [(W_c + W_m) \times L] \times 9.81 \text{ (N)} \end{aligned}$$

$$\begin{aligned} \text{Vertically downward} \\ \text{Pull} &= [(W_c + W_m) \times -L] \times 9.81 \text{ (N), i.e. negative} \end{aligned}$$

$$\begin{aligned} \text{Horizontal section} \\ \text{Pull} &= [(W_c + W_m) \times L \times \mu_c] \times 9.81 \text{ (N)} \end{aligned}$$

$$\begin{aligned} \text{Inclined section} \\ \text{Pull} &= [(W_c + W_m) \times L \times \mu_{s2}] \times 9.81 \text{ (N)} \end{aligned}$$

$$\begin{aligned} \text{Declined section} \\ \text{Pull} &= [(W_c + W_m) \times L \times \mu_{s1}] \times 9.81 \text{ (N)} \end{aligned}$$

$$\begin{aligned} \text{For } 180^\circ \text{ sprocket lap} \\ \text{Pull} &= \text{Total pull at entry} \times 1.05 \text{ (N)} \end{aligned}$$

$$\begin{aligned} \text{For } 90^\circ \text{ sprocket lap} \\ \text{Pull} &= \text{Total pull at entry} \times 1.025 \text{ (N)} \end{aligned}$$

$$\begin{aligned} \text{For bend section} \\ \text{Pull} &= \text{Total pull at entry} \times e^{\mu_c \theta} \text{ (N)} \end{aligned}$$

Chain pull calculations for the example would be:

Section	Cumulative Total (N)
A - Horizontal Section $[(W_c + W_m) \times L \times \mu_c] \times 9.81$ $[(19.68 + 0) \times 1 \times 0.15] \times 9.81 = 29\text{N}$	29
B - 90° sprocket lap $29 \times 1.025$	30
C - Vertically down $[(W_c + W_m) \times -L] \times 9.81$ $[(19.68 + 0) \times -3.6] \times 9.81 = -695\text{N}$	0 (-665)*
D - 90° sprocket lap $0 \times 1.025$	0
E - Horizontal section $[(W_c + W_m) \times L \times \mu_c] \times 9.81$ $[(19.68 + 0) \times 16.5 \times 0.15] \times 9.81 = 478\text{N}$	478 (-665)*
F - 90° sprocket lap $478 \times 1.025$	490
G - Vertically up $[(W_c + W_m) \times L] \times 9.81$ $[(19.68 + 0) \times 1] \times 9.81 = 193\text{N}$	683

H - 90° sprocket lap	683 x 1.025	700
I - Horizontal section	$[(19.68 + 65.62) \times 15 \times 0.15] \times 9.81 = 1883\text{N}$	2583
J - 180° sprocket lap	2583 x 1.05	2712
K - Horizontal section	$[(19.68 + 65.62) \times 15 \times 0.15] \times 9.81 = 1883\text{N}$	4595
L - 180° sprocket lap	4595 x 1.05	4825
M - Horizontal section	$[(19.68 + 65.62) \times 10 \times 0.15] \times 9.81 = 1255\text{N}$	6080
N - Bend section	6080 x $e^{\mu_c \theta}$ 6080 x 1.082	6579
P - Inclined section	$[(W_c + W_m) \times L \times \mu_{s2}] \times 9.81$ $[(19.68 + 65.62) \times 3 \times 0.63] \times 9.81 = 1582\text{N}$	8161
Q - Bend section	8161 x $e^{\mu_c \theta}$ 8161 x 1.082	8830
R - Horizontal section	$[(19.68 + 65.62) \times 4 \times 0.15] \times 9.81 = 502\text{N}$	9332 (-665)

∴ Total chain pull  $C_p = 9332\text{ N}$  **\*NOTE:** The negative figure is ignored when establishing chain strength required. However, this figure is taken into account when calculating headshaft power or torque.

Using a general safety factor of 8, then chain breaking load required would be:

$$\frac{9332 \times 8}{2} = 37328 \text{ (N) per chain}$$

As a hollow bearing pin chain will be required for fitting the staybars then 2 strands of 54 kN (12000 lbf) chain of 152.4 mm (6" pitch) would be suitable. It would now be correct to recalculate the above using the actual mass of 54 kN (12000 lbf) chain and  $\mu_c$  from the friction factors listed on page 72 table 2.

From catalogue, Chain total mass  $W_c = 4.89\text{ kg/m}$  per chain  
 For two chains  $= 9.78\text{ kg/m}$  total  
 Total mass of chain + staybars  $= 9.78 + 9.84 = 19.62\text{ kg/m}$   
 Coefficient of friction  $\mu_c = 0.14$  (occasional lubrication)

By recalculating, the maximum chain pull would be 8805 (N) with negative value 665 (N).

$$\text{Safety Factor} = \frac{2 \times 54000}{8805} = 12.3$$

This is quite satisfactory.

Due to the bend sections it is necessary to check the imposed roller load due to the bend and staybar loads.

$$\begin{aligned} \text{Load at staybar} &= \frac{[20 + 3 + (9.78 \times 304.8)] \times 9.81 \text{ (N)}}{1000} \\ &= 255 \text{ N} \end{aligned}$$

$$\text{Load per roller } R = \frac{255}{2} = 127.5 \text{ N}$$

Bearing area of roller  $= 420\text{ mm}^2$  (See page 12 table 3)

$$\text{Bearing pressure } P = \frac{127.5}{420} = 0.3 \text{ N/mm}^2$$

$$\text{Imposed load due to bend} = \frac{\text{Pull at exit (N)} \times \text{Pitch (m)}}{\text{Bend Rad (m)}}$$

On recalculating, pull at exit of top bend (Q) = 8337 N

$$\therefore \text{Imposed load} = \frac{8337 \times 0.3048}{2} = 1271 \text{ N}$$

$$\text{Imposed load per roller} = \frac{1271}{2} = 636 \text{ N}$$

$$\therefore \text{Total roller load } R = 636 + 127.5 = 763.5 \text{ N}$$

$$\text{Bearing pressure } P = \frac{763.5}{420} = 1.82 \text{ N/mm}^2$$

As this series of chain has a sintered steel roller, maximum allowable pressure  $P = 1.2\text{ N/mm}^2$  at 0.5 m/sec.

Our figure of  $1.8\text{ N/mm}^2$  is above this figure but as the chain speed is only 0.067 m/sec, the  $P V_R$  value for average conditions can be checked by the method shown on page 73-74.

$$\begin{aligned} \text{Rubbing speed } V_R &= \frac{\text{Chain speed (m/sec)} \times \text{roller bore (mm)}}{\text{Roller dia (mm)}} \\ &= \frac{0.067 \times 23.6}{47.6} = 0.033 \text{ m/sec} \end{aligned}$$

$$\therefore P V_R = \text{Pressure} \times \text{Rubbing Speed}$$

$$= 1.82 \times 0.033 = 0.06$$

Maximum  $P V_R$  for average condition for a sintered steel roller is 0.30.

∴ The standard roller is satisfactory.

∴ Use 2 strands of 54 kN (12000 lbf) chain, 152.4 mm pitch, chain no. 105241/16.

$$\begin{aligned} \text{Power required at headshaft} &= \frac{C_p \times V}{1000} \text{ kW} \\ &= \frac{(8805 - 665) \times 0.067}{1000} \\ &= 0.55 \text{ kW} \end{aligned}$$

$$\begin{aligned} \text{PCD (12 tooth)} &= 588.82 \text{ mm} \therefore \text{RPM} = \frac{V \text{ (m/sec)} \times 60}{\text{PCD (m)} \times \pi} \\ &= \frac{0.067 \times 60}{0.58882 \times \pi} \\ &= 2.2 \text{ RPM} \end{aligned}$$

$$\begin{aligned} \text{Headshaft torque} &= (8805 - 665) \times \frac{0.5882}{2} \text{ Nm} \\ &= 2394 \text{ Nm} \end{aligned}$$

### BUCKET ELEVATOR - DYNAMIC DISCHARGE

This system incorporates a series of buckets attached at intervals to one or two chains as shown. Material to be moved is fed into the elevator boot by an inclined chute. The buckets then collect it by a scooping or dredging motion. Discharge relies on the velocity to throw the material clear of the preceding bucket.

Fig. 25

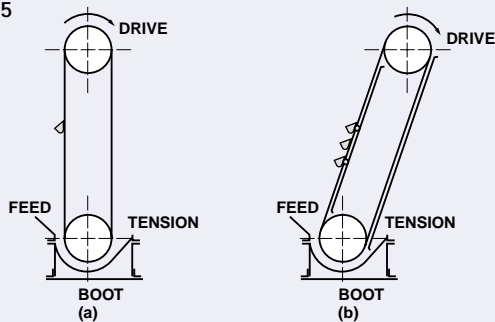

- a. High speed with dredge feed and dynamic discharge.
- b. Medium speed with dredge feed and dynamic discharge.

Fig. 26

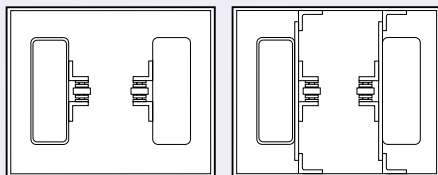

This type is particularly useful for handling materials not exceeding 75mm cube. Materials having abrasive characteristics can be dealt with, but a high wear rate of buckets and chain must then be accepted. Versions with both single and double strand chain are commonly used, the selection of the latter type depending on the width of bucket required. Two chain strands are necessary if the bucket width is 400mm or more. It is usual to operate elevators of this type at a chain speed of about 1.25 to 1.5m/sec, but each application must be considered individually in relation to achieving an effective discharge, the latter being dependent on the peripheral speed of the bucket around the head sprocket. Other important factors influencing discharge are the type of material, bucket shape and spacing.

Feed chute angles vary with the materials handled but are generally arranged at 45° to the horizontal. Material should be fed to the buckets at or above the horizontal line through the boot sprocket shaft. Where bucket elevators are an integral part of a production process, it is usual to have interlocks on the conveyor and elevator systems to avoid unrestricted feed to any unit which may for some reason have stopped.

The selection of the correct shape and spacing of the buckets relative to the material handled, are important factors in efficient operation. Spacing of the buckets depends upon the type of bucket and material handled, but generally 2 to 2.5 times the bucket projection is satisfactory. Bucket capacities as stated by manufacturers are normally based on the bucket being full, but this capacity should be reduced in practice to about 66% or water level to ensure that the desired throughput is obtained.

Solid bearing pin chain is essential for other than light, clean duty application. Chain pitch is normally dictated by bucket proportions and desired spacing. Mild steel case hardened rollers should be used but where these are not required for guiding purposes, smaller diameter gearing rollers of the same material are preferred.

Due to the high loadings which can occur during dredging, particular care is necessary in ensuring that the chain attachments, buckets and bucket bolts are sufficiently robust to withstand these loadings. Normally K2 welded attachments are used; fig. 26 illustrates typical examples. This means that lower chain speeds can be used to effect adequate material discharge speeds, as the buckets operate at a greater radius than the sprocket pitch circle diameter. Integral attachments are not recommended for this type of elevator.

The selection of the head sprocket pitch circle diameter is related to obtaining correct discharge as described later. Generally the head sprocket should have a minimum of 12 teeth, otherwise the large variation in polygonal action which occurs with fewer numbers of teeth will cause irregular discharge and impulsive loading. This will result in increased chain tension, greater chain wear and stresses on the buckets. Where the material handled has abrasive characteristics and/or high tooth loadings exist, steel sprockets are necessary. For extremely high engaging pressure the sprockets should have flame hardened teeth.

To aid bucket filling the boot sprocket size should be the same as that of the head sprocket. Where abrasive materials are involved boot sprockets should be manufactured from steel. Irrespective of size or material handled the boot sprocket teeth should be relieved to reduce material packing between the tooth root and the chain. (See page 45 Fig. 3).

Chain adjustment is normally provided by downward movement of the boot shaft, and allowance should be made for this in the boot design. Certain materials handled by this type of elevator have a tendency to pack hard, and therefore material in the boot should be cleared before adjusting the chains to avoid fouling.

On long centre distance installations, guiding of the chain is necessary to avoid a whipping action which can be promoted by the dredging action. It is not always necessary to provide continuous guide tracks, and common practice on say a 20m elevator would be to introduce three equally spaced 2m lengths of guide for each strand of chain.

Inclined elevators must have continuous chain guides irrespective of the length of the elevator. The discharge sequence of a dynamic discharge elevator is shown on Fig. 27.

Fig. 27

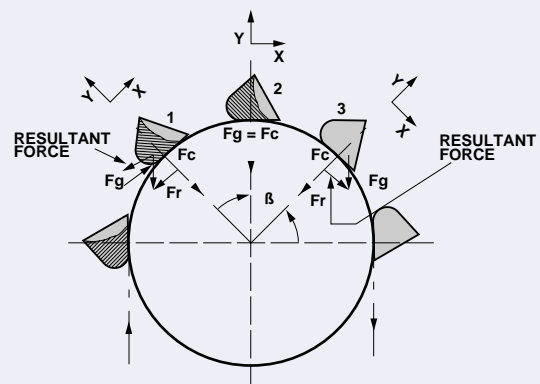

Newton's first law states that "Every body will continue in its state of rest or uniform motion in a straight line unless compelled to change that state of rest or uniform motion".

The application of the first law to an elevator discharge means that as an elevator bucket moves around a chain sprocket, at the top of the elevator, then the material in the bucket will try to continue in a straight line from any position on the sprocket. The material will therefore attempt to move in a path parallel to the tangent to the chain sprocket. At any point on the circular path the material is attempting to move in a straight line and the only restraining force is gravity acting vertically downwards.

### At Position 1 (Fig. 28)

The gravitational force  $F_g$  can be split into two components:

- Centripetal force towards the centre of the wheel which works to ensure the material travels in a circular path.  $F_c$ .
- A component force at  $90^\circ$  to a., which presses the material into the bucket.  $F_r$ .

Fig. 28

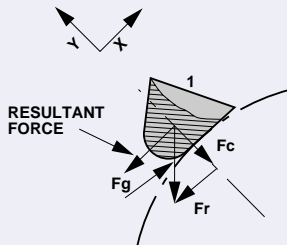

The net effect of the forces at position 1 is that the material is held into the bucket and not allowed to discharge at this point unless the speed of the chain is excessive. In that case the gravitational force would not provide sufficient centripetal force to ensure that the material followed the bucket path, and material would flow over the outer lip of the bucket.

### At Position 2 (Fig. 29)

At position 2 the gravitational force  $F_g$  and centripetal force  $F_c$  are in line and for many materials handled it is the design objective to ensure that discharge begins to occur at this point. To achieve this the speed of rotation should be such that the gravitational force exactly balances the centripetal force required to maintain the material in a circular path.

Fig. 29

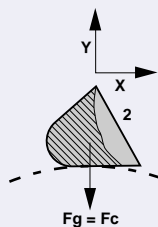

Given this situation the material is in effect weightless and immediately after the top centre position the material will begin to discharge from the bucket, see fig. 30 for position 3.

### At Position 3 (Fig. 30)

At position 3, where the bucket will completely discharge, the gravitation force  $F_g$  can be resolved into two components  $F_r$  and  $F_c$ . If the resolved component of  $F_c$  is not sufficient to ensure that the material will continue on a circular path then the material will discharge on a tangential path subject only to the effects of air resistance and gravity.

Fig. 30

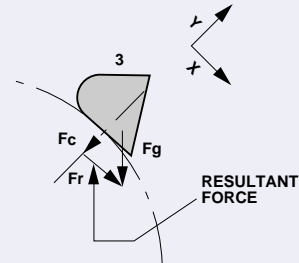

- Gravitational force,  $F_g = mg$
- Centripetal force,  $F_c = \frac{mv_m^2}{r_m}$

Where  $m$  = material mass in the bucket, (kg)  
 $g$  = gravitation acceleration, i.e.  $9.81\text{m/sec}^2$ .  
 $V_m$  = linear velocity, chain speed - (m/sec), at radius  $r_m$   
 $r_m$  = radius of material from centre of wheel - (m).

- At the balance point at top centre  $mg = \frac{mv_m^2}{r_m}$  (Position 2)
- $\therefore V_m^2 = r_m g$   $V_m = \sqrt{r_m g}$

For heavy and coarse materials, such as coal or rock, it is the usual practice to delay discharge until after the top centre position.

The formula then is modified to:

- $V_m^2 = 0.7 r_m g$   $\therefore V_m = \sqrt{0.7 r_m g}$

This is the required linear speed for the material at a radius of  $r_m$  around a sprocket. It is now possible to calculate the angle  $\beta$  (see fig. 27 page 84) which is the angle at which the bucket will discharge. For heavier materials such as coal and rock this is usually about  $40^\circ$ .

$$\text{Centripetal force} = \frac{mv_m^2}{r_m}$$

Also the centripetal component of gravitational force at point of discharge.  $F_c = mg \cos \beta$ .

$$\therefore mg \cos \beta = \frac{mv_m^2}{r_m}$$

- $\therefore \cos \beta = \frac{V_m^2}{r_m g}$  where  $\beta$  is the discharge angle.

Note! It is usual to calculate the discharge values at both the tip and the back of the bucket. It is therefore necessary to calculate the value of  $\cos \beta$  for both cases using the respective values for  $r_m$  and  $V_m$ .

When the material leaves the bucket it will have the tendency to travel in a straight line but will be immediately acted upon by gravity.

To determine the trajectory of the material it is then necessary to plot the path from this discharge point by resolving the initial velocity into vertical and horizontal components.

The vertical component will be:

$$V_g = V_m \cos (90-\beta) = V_m \sin \beta$$

and the horizontal component will be:

$$V_h = V_m \sin (90-\beta) = V_m \cos \beta$$

## Designer Guide

At intervals of say 0.5 seconds it is now possible to plot the trajectory of the material by using the following formulae:

$$7. \quad Dv = V_g t + 1/2 g t^2$$

$$8. \quad Dh = V_h t$$

Where  $Dv$  = vertical displacement (m).  
 $Dh$  = horizontal displacement (m).  
 $V_g$  = initial vertical velocity (m/sec).  
 $V_h$  = initial horizontal velocity (m/sec).  
 $t$  = elapsed time (seconds).  
 $g$  = acceleration due to gravity, i.e.  $9.81 \text{ m/sec}^2$ .

If the speed selection sets the discharge point at top centre then the initial vertical velocity will be zero, and formula 7 becomes:

$$Dv = 1/2 g t^2$$

Some elevator designs, in an attempt to economise on casing size, use small head wheels and large bucket projections. In these cases it is necessary to check the discharge characteristics for both the back and the tip of the bucket rather than, as previously described, the centre of gravity of the material.

In such designs it is possible to achieve a good discharge from material at the tip of the bucket while material at the back of the bucket has insufficient velocity and will fall back down the elevator, and if the back of the bucket discharges correctly then the tip will discharge before top centre. Such designs are false economy, as to achieve an adequate capacity it is necessary to oversize the elevator to compensate for the material recirculated by not discharging correctly.

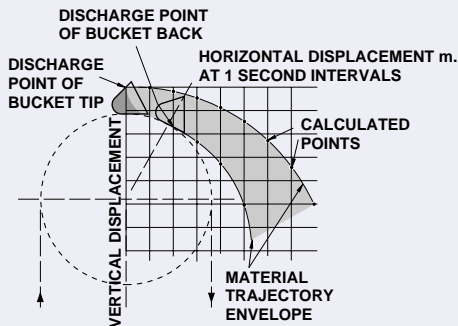

### POSITIVE DISCHARGE ELEVATOR

Fig. 31

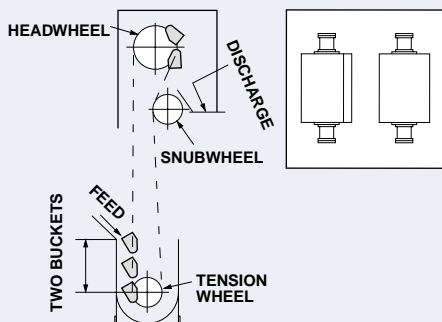

This type of elevator has a series of buckets fixed at intervals between a pair of chains. The method of pick-up on this type of elevator is usually by direct filling of the bucket. The shape of the buckets used, the angle back type, is such that they cannot dredge efficiently and the material must be fed directly into them. A sensible rule to ensure good filling is that the lowest point on the inlet chute

should be two bucket pitches above the highest position of the tail/tension shaft. Some material will inevitably escape and fall into the boot but this will be only a small proportion of the throughput and the buckets can be relied upon to dredge this small amount.

The chains are mounted on the ends of the buckets as shown in fig. 31. This arrangement facilitates the discharge operation which, due to the slow speed of the elevators, is accomplished by inverting the bucket, the contents of which fall clear, or in some cases slide down the back of the preceding bucket.

Because of their particular function, and consideration of space, snub sprockets are smaller than the head and boot sprockets. On high capacity elevators they are subjected to impact tooth loading, caused by the reaction load of the hanging chain and buckets descending after negotiating the head sprocket. This tooth impact will be greatest at the bucket positions, and therefore if, as is usual, the buckets are spaced at an even number of chain pitches, the snub sprocket should have an odd number of teeth to equalise wear. Conversely, if the buckets are unevenly spaced relative to chain pitch, an even or odd number of sprocket teeth can be used providing the selected number is not divisible by the bucket spacing.

The recommended snub sprocket position is shown in fig. 32, the distance E-F being the equivalent of an equal number of pitches plus half a pitch; normally 4.5 are satisfactory. Snub sprockets should be of steel with flame hardened teeth.

To find the best position for the snub sprocket on a particular application it will be necessary to first set out the discharge characteristics of the buckets relative to the elevator discharge chute to ensure a full and clean discharge, bearing in mind that the material will fall out of the buckets due to gravity alone, and secondly to calculate the chain length between the head sprocket and snub sprocket to ensure that the 'even pitch length plus a half pitch' rule is observed.

The method of calculation of this length is as follows:

Fig. 32

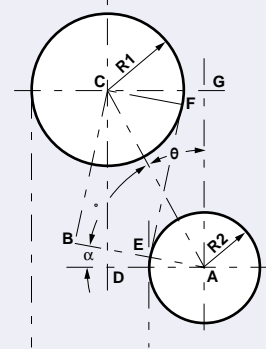

$$AC = \sqrt{AD^2 + CD^2} \text{ in } \triangle ADC$$

$$AB = R_1 + R_2$$

$$BC = \sqrt{AC^2 - AB^2} \text{ in } \triangle ABC$$

$$\sin \beta = \frac{BC}{AC} \text{ in } \triangle ABC$$

$$\sin \theta = \frac{AD}{AC} \text{ in } \triangle ACD$$

$$AD = CG$$

$$\alpha = 90^\circ - (\beta + \theta)$$

Compare this with the theoretical ideal where  $a = \frac{360}{N}$

where N is the number of teeth on the snub sprocket.

Length EF = BC

Calculate EF in pitches, i.e.  $\frac{EF}{\text{Chain Pitch}}$

This figure should be  $X + 1/2$  where X is a whole number of pitches. The minimum value must be  $4\frac{1}{2}$  chain pitches.

### BOX SCRAPER CONVEYOR

#### Description and chain type

The box scraper type of conveyor can use either a single strand or two strands of chain. The general construction is that of an enclosed box or trunking in which the chain is submerged in the material. The conveying movement relies on the 'en masse' principle, where the cohesion of the particles of material is greater than the frictional resistance of the material against the internal surface of the box. Because of this feature, a remarkably large volume of material can be moved by using flights of quite small depth.

In general a depth of material approximately equal to 2/3 of the conveyor width can be successfully conveyed by the 'en masse' principle.

The bottom surface of the box which supports the material is also used to carry the chain (fig. 33).

Fig. 33

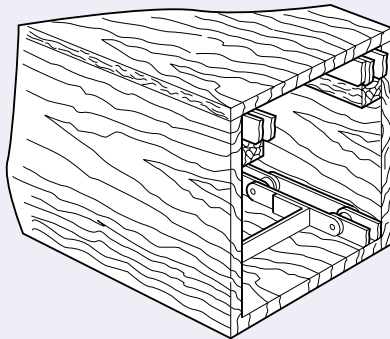

When conveying non-abrasive and free flowing material, such as grain, a chain speed of up to 0.5-0.6m/sec is practicable. For aeratable materials however, as for example cement or pulverised starch, the chain speed must be reduced to 0.25m/sec maximum.

Excessive speeds reduce efficiency as the chain and attachments tend to pull through the material, leaving the top strata either stationary or moving at reduced speed; furthermore, turbulent conditions may be set up. For stringy, flaky and sticky materials, a speed of 0.2m/sec should not be exceeded. Abrasive materials increase the amount of maintenance required, and to keep this within reasonable bounds the chain speed should not be more than 0.15m/sec. In ideal handling situations, e.g. dry grain, it is possible for the speed to be increased above the 0.5-0.6m/sec as the conveyor width increases. The effect of the side friction, which causes a 'boundary layer' of slower moving (and almost stationary) material becomes less significant as a percentage of the moving mass of material. On wide scraper conveyors speeds of up to 0.8m/sec are common.

The operating principle depends, as stated, on the material having free flowing properties. Conveying can if desired be carried out contra-directionally by using both top and bottom runs of the chain. Operation is confined to straight sections, but these may incline from the horizontal. The amount of inclination is largely governed by the repose angle of the material and depth of the scraper. Effectiveness of flow can be prejudiced on inclines, and when handling grain for example, the maximum inclination from the horizontal should not exceed 15°.

Some loss of conveying efficiency will be caused by the inclines which will become progressively more significant as the angle approaches 15°.

The feed-in to the box may take the form of a manually fed side chute or a hopper with regulated feed. Alternatively the chain assembly itself can function as a regulator, as shown in fig. 34.

Fig. 34

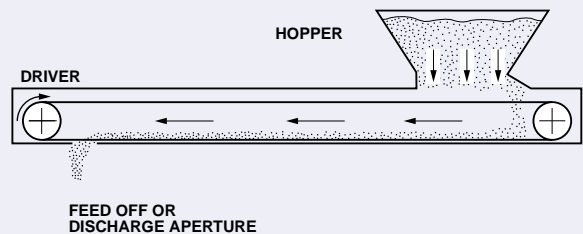

Standard chain of any size or strength may be adapted to the system. It is usual for the chain rollers and scraper plate depth to be equal to chain plate depth thus ensuring that as flat a surface as possible is moving along the scraper floor. Bush chain is sometimes used, but the roller type is recommended wherever possible to avoid high pressure movement between the bush and the sprocket tooth as the chain engages with the sprocket.

The chain pitch is normally governed by the required proportions of the box allied to the linear spacing of the scraper. Sprocket sizes are generally governed by box proportions, 8 or 12 teeth being commonly used. Head and tail sprockets are normally cast iron with cast teeth and should have relieved form to reduce packing of material between the chain and the teeth. See fig. 55, page 93.

Integral L attachments as illustrated in fig. 35, may be used in either single or double strand light duty systems.

Fig. 35

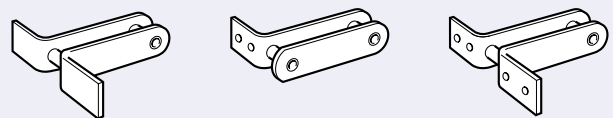

For some series of chain double strength versions are available, which are dimensionally identical to the base chain but have twice the breaking strength. However pin/bush bearing areas are as the original chain.

Suitable applications for double strength chain are on systems with long centres but limited use, where chain wear would not be a problem, where shock loads are likely on an intermittent basis and where failure of chains would be catastrophic to production.

In addition to using L attachments, special scraper attachments are available, an example of these being shown on page 88 fig 36.

Fig. 36 Scraper Attachments

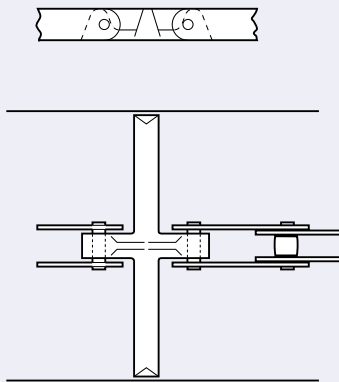

4

The advantages of this type of scraper are:

- Use of steel conveyor chain retains the advantage of large bearing area and high hardness at articulation points.
- The weight of malleable iron scrapers tends to maintain the chain on the box base. This is further assisted by the angled face of the scraper.
- The relatively high tensile working loads enable long centre distance conveyors to be used.
- A continuous unbroken scraping surface is presented to the material being conveyed.
- The limited area of the top of the malleable scraper reduces material carry-over across the discharge aperture to a minimum.

Whilst this type of chain was introduced primarily for the handling of damp grain, it is used successfully for other free flowing granular materials such as animal food pellets, cotton seed, pulverised coal, cement, etc. and it has also been found to successfully handle dry grain and similar materials when the depth of material is maintained at the 2/3 of width criterion.

The chain can operate in either direction but conveying of material can only be done on one strand of the chain, which in fig. 37 below is the bottom strand.

Fig. 37

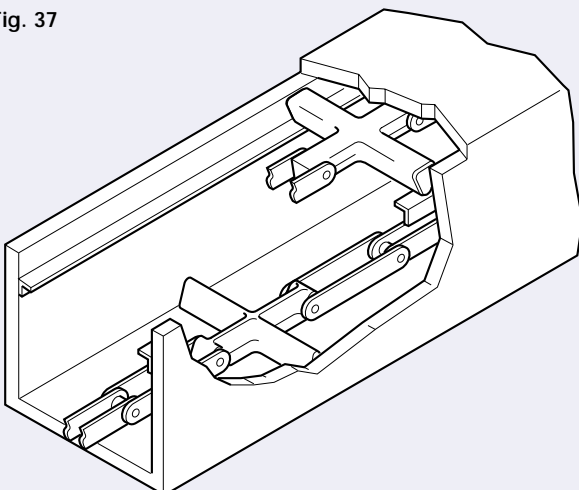

## BLOCK CHAIN

A variation on the standard design of steel conveyor chain is the block chain. The block chain (Fig 38) is comprised of just outer links, inner block links and pins, and has the advantage that for use in hostile environments there are fewer moving parts to wear.

Fig. 38

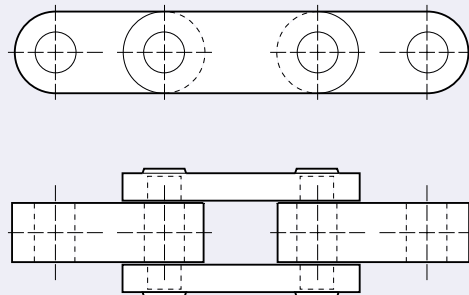

The pins are a tight fit in the outer side plates and a clearance fit in the inner block link and for most applications it is not necessary to incorporate any heat treatment other than to case harden the pin bearing surface.

For heavy duty applications a case hardened bush can be pressed into the centre block link holes to enhance the wear properties.

The absence of a roller removes a source of problems in arduous applications but this means that the chain must slide on the side plate edges, thus increasing the power requirement of the conveyor because of the higher friction factor. An additional feature is that the side plate edges can be induction hardened to reduce the rate of wear due to sliding.

Block chain is often used for high temperature applications where it is not possible to protect the chain from heat.

At temperatures of up to 300°C, low carbon steel materials can be used for heat treated components such as the pin.

Above 300°C and up to 450°C then alternative materials with tempering temperatures above 450°C must be used to avoid softening and loss of wearing properties. At temperatures above 450°C there are two main options:

1. To use special heat resistant steels. It is rarely economic to specify these steels due to the difficulty of obtaining them in the small batch quantities used in most block chain production.
2. To treat the chain as sacrificial and accept that a relatively short life will be experienced at high temperature.

If neither of these options is acceptable the system design should be examined to determine a method of protecting the chain from the heat and using a chain suitable for the expected chain temperature.

Block chain is also used extensively in highly abrasive environments where their minimum of moving parts and relatively cheap cost ensures that they are an option worth considering.

### GALLE CHAIN

Patented by a Frenchman named Galle in 1830, this chain pre-dates the familiar chain of pin/bush/roller construction by several decades, and is still used today for selected applications.

It may be described as similar to leaf chain but built in a double strand system with the bearing pins also providing a sprocket gearing member between the strands. This means that, unlike leaf chain, it can be driven by or pass over toothed wheels rather than plain pulleys if required.

Standards exist for Galle chain and a derivative known as draw bench chain, which specify the chain pitch, plate and pin dimensions, numbers of link plates per pitch and given breaking loads. However, variations on these standards are often introduced for specific applications.

**Fig. 39** Typical 8x8 Combination Galle Chain - Detachable Type

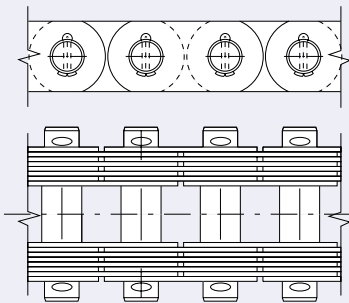

Galle chain is normally used for very slow moving lifting applications, for example in large flood water control sluice gates. Draw bench chain, especially with hardened steel bushes in the link plate holes and hardened pin surfaces, is used in wire and tube drawing mills where chain speeds of up to 1 m/sec can be allowed.

The chain may be of rivetted or detachable construction, the latter enabling length adjustment and occasional dismantling for safety inspections.

Surface coatings such as dry film lubricants or zinc can be added for special applications and because the chain is often exposed to the elements, heavy protective greases or other coatings are applied in service.

The Galle chain is normally subjected only to occasional use at very slow speed and therefore, despite the usual non-hardening of plate hole and pin rubbing surfaces, long chain life is achievable. More frequent use may demand an induction hardened surface to the pin.

Because this chain is not manufactured to the highest standards of dimensional accuracy and surface finish and because the plate/pin assemblies have clearance fits allowing hand assembly, the Galle and draw bench chains provide a lower cost/strength ratio compared to other types of chain, and are therefore a more economic solution in selected cases.

If the designer feels that this type of chain may be suitable for a particular application he should contact the Renold Technical Sales Department for advice.

### CONVEYOR CONSTRUCTION

Conveyors and elevators come in many variations, sizes and degrees of complexity, but there are certain points which should be borne in mind when designing any conveyor or elevator.

**Fig. 40**

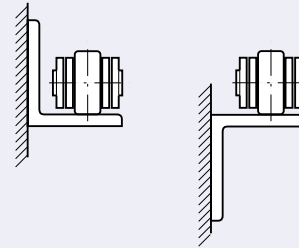

Generally, support tracks are required for both the loaded and unloaded strands of a conveyor chain. For this purpose, commercially rolled angles or channel are normally used, as shown in fig 40. Tracks should be made of adequate strength to prevent deflection or twisting under dynamic load conditions, they should be correctly aligned, and those sections subject to heavy wear should be fitted with renewable wear strips. Joints should be smooth and free from any projections such as welds, etc.

**Fig. 41**

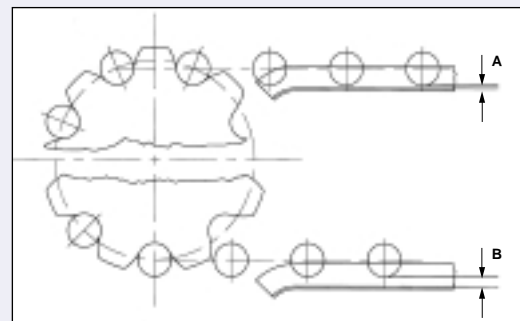

The relationship between the chain rollers, the sprocket and the support tracks should be as shown on Fig. 41 with dimension A a minimum of 5mm and dimension B a minimum of 10mm. This allows the chain to lift into and fall out of engagement with the sprocket and reduces wear on the chain rollers and the track.

At sprocket positions, the track ends should be provided with adequate lead-in and -off radii (Fig 41), and set as close as possible to the sprocket. To determine the optimum track setting, it is usual to set out the chain and wheel positions (as shown). The width of the track must allow full seating of the roller width and avoid the possibility of the bearing pin ends fouling the structure.

Tracks should at all times be maintained in a clean condition, free from dirt, superfluous lubricant and other extraneous matter.

Minimum track radii relative to pitch and roller diameter for all chain series, to avoid the side plates catching the chain guides, are given in table 7 page 76. Return strands may be carried on toothed or plain faced idler wheels, this method being particularly suited for slat or apron plate conveyors, where full width slats would prevent the return strand using the chain rollers. The spacing of the wheels will in each case be determined by the particular application. As a pull will be induced in the chain due to catenary or chain 'sag' between the supporting wheels, generally wheels are spaced 2 to 3 metres apart.



### Chain Guiding

Fig. 42

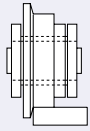

Fig. 43

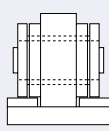

Fig. 44

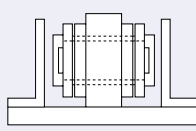

Fig. 45

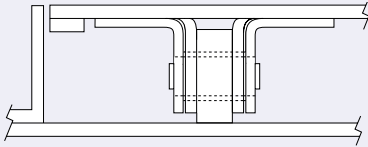
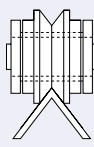

Fig. 46



4

Simple methods used are:

1. The use of chain with flanged rollers, fig. 42.
2. By guiding the chain rollers between continuous strips spaced along the length of track, fig. 43.
3. The fitting of pads to the chain to limit side movement by bearing against a side guide. Such pads may be bolted, rivetted or sometimes welded to chain plates, or alternatively fitted through chain hollow bearing pins. They are normally not required at every pitch and for most applications a linear spacing of 1 metre is adequate, fig. 44.
4. By the slat end faces rubbing against guide tracks. In this case it is common to fit wearing strips on the ends of the slats, fig. 45.
5. By use of Vee tread rollers on one chain, running on an inverted angle section track, fig. 46.

### Conveyor Drives

Conveyors and elevators are normally driven at the position of maximum load pull in the chain circuit. On simple conveyors of the horizontal or inclined slat type, this position coincides with the delivery or off-load end of the system. This ensures that the loaded length of the chain is taut, and the return length slack.

The most commonly accepted and widely adopted method of providing a final drive to a conveyor or elevator chain is by toothed sprocket.

Fig. 47

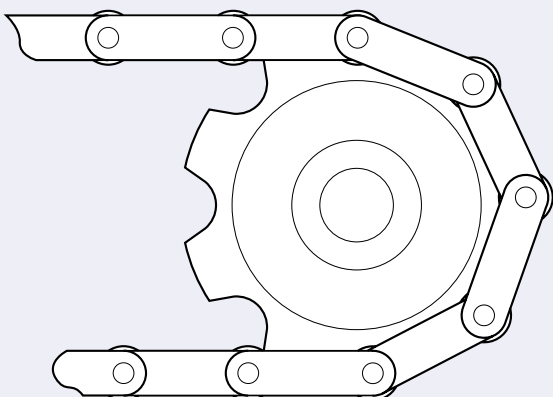

The aim should be to provide a driving lap angle on the sprocket of 180°, but this is not always possible, particularly on complicated circuits. The general rule, therefore, should be never to have less than 3 teeth in engagement.

Conveyors having several sections, e.g. tiered drying ovens, may need to be driven at more than one point, all driving points being synchronised. In general, such conveyors should have one driver sprocket for every seven idler sprockets.

The simplest method of ensuring drive synchronisation is to take chain drives of identical ratio to each conveyor drive point from one common drive shaft. Careful attention to the conveyor layout design sometimes allows the drive points to be located fairly close to each other, but if this is not possible then two or more prime movers will have to be used. These drives will need to be electrically interlocked or have slip characteristics incorporated to prevent 'hunting'.

An alternative method of driving conveyor chain is by caterpillar drive (see fig. 48). Two types of caterpillar drive are available, i.e. hinged or fixed tooth. The former has the advantage that the load on the tooth is taken by a roller in the tooth and not by the chain rollers, but these can only be used to drive in one direction. With the fixed tooth type the load is taken by the chain rollers and can be used for a reversing drive.

Fig. 48

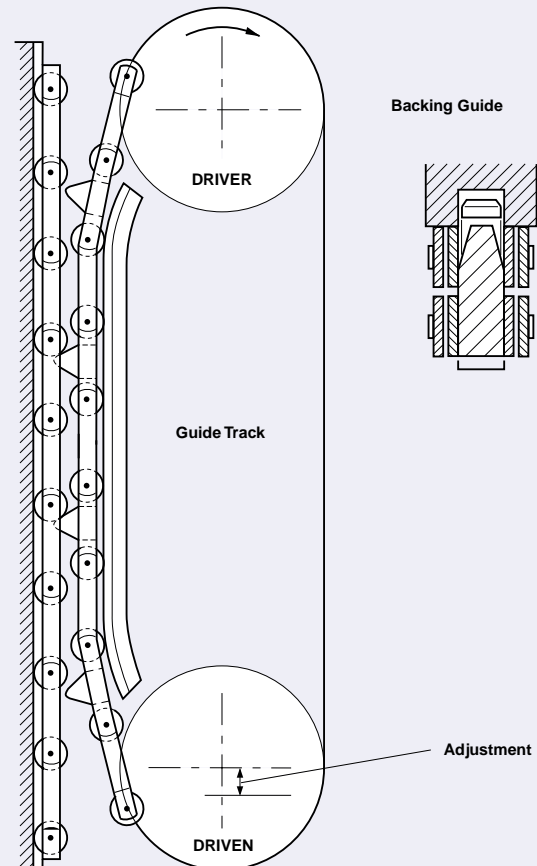

### Chain Adjustment

For optimum performance and correct running, all chain systems should be provided with means to compensate for chain elongation due to wear. Normally, on a chain conveyor or elevator, pre-tensioning of the chain is not necessary. The only adjustment required is the 'take-up' of the clearance between the pins and bushes in each link, and this should be done before the conveyor is run.

The amount of adjustment should allow for the joining up of the chain and elongation due to wear. Wherever possible the adjusting sprocket or track should be positioned at a convenient point immediately following the drive sprocket. This ensures that the effort required to adjust the chain is at a minimum. Take-up positions should, if possible, be introduced at positions where the conveyor makes a 180° bend Fig 49. At these positions, the chain take-up will be equal to twice the adjustment. If a 90° position is unavoidable, then track movement is necessary, particularly on overhead conveyors.

Where multiple drives are used it is preferable to provide an adjustment for each drive point.

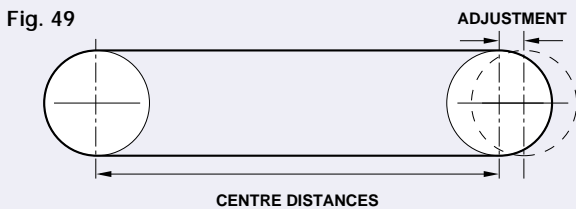

### Methods of Adjustment

The most common type of adjuster in use is the screw take-up. In this arrangement the tail shaft bearings are mounted in slides and adjusted by screws. When the correct chain tension is achieved the bearings are then locked in position (Fig. 50).

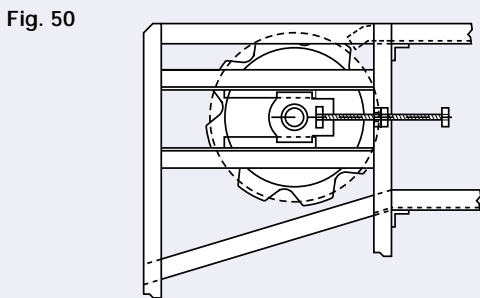

There are basically five methods of achieving automatic adjustment and the aim of each method should be to impose a minimum adjusting load or tension in the chain consistent with the removal of chain slack, particularly during variations in load conditions. Such methods are dead weight, spring, pneumatic or hydraulic, counterweight and chain catenary take-up. Before deciding upon which of these methods to use it is advisable to consult our engineers, or a specialist in conveyor manufacture, as each system has its advantages and disadvantages.

### Routine Adjustment

A chain system should be maintained in correct adjustment throughout its life. Early adjustment will probably be found necessary due to initial 'bedding in' of the mating components. The amount of total adjustment throughout a chain's life varies according to the length and pitch of the chain and can be estimated as follows:

$$\text{Adjustment (mm)} = \frac{\text{Centre distance (mm)} \times \text{factor}}{\text{Chain pitch (mm)}}$$

For adjustment factor see table 9.

Table 9

ADJUSTMENT FACTORS			
BS		ISO	
Chain Series	Factor	Chain Series	Factor
13-20kN	0.406	M40	0.76
27-33kN	0.508	MC56	0.71
54-67kN	0.762	M80	1.02
107-134kN	1.016	MC112	0.97
160-200kN	1.016	M160	1.32
267kN	1.270	MC224	1.28
400kN	1.270	M315	1.68
		M450	1.80
		M630	2.03

When a chain has been adjusted to this extent it will be worn out and due for replacement. Where the calculated figure exceeds twice the pitch of the chain, then a minimum adjustment of plus 1.5 pitches, minus 0.5 pitch on the nominal centre distance should be provided. This amount of adjustment will allow the removal of two pitches of chain as wear occurs, the negative adjustment providing sufficient slack for the initial connecting up of the chain.

Fig. 51

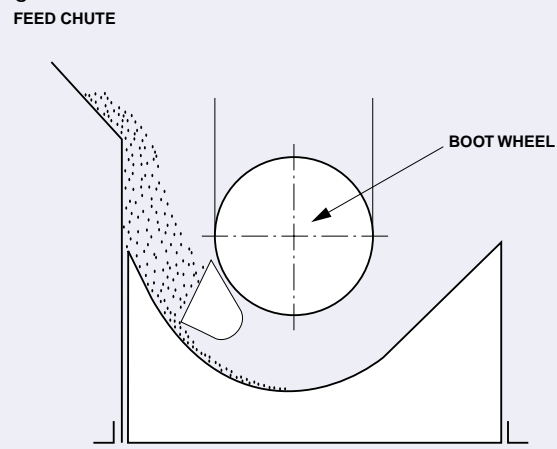

On dredging feed elevators, where the boot wheel is the adjustable member, provision should be made not only for sprocket adjustment but also for the boot curved plate so that the buckets maintain a constant clearance, see fig. 51.

### STAYBAR OR SLAT STIFFNESS

Many conveyors use slats, staybars or similar components to join two chains together and/or carry the conveyed loads. To ensure that the chain runs satisfactorily it is important that the staybars or slats are sufficiently stiff so that the chain is not tilted to one side when loaded. This can be done by limiting the slope due to deflection at each end of the staybar/slat to 0.5° (0.0087 radians).

Fig. 52

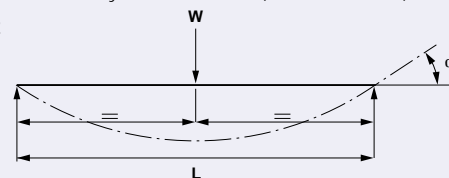

The maximum load or strength of the staybar/slat can then be calculated as follows. (Assuming a simply supported beam).

For a central load  $\alpha = \frac{WL^2}{16EI}$  where 16 = constant

For a uniformly distributed load  $\alpha = \frac{WL^2}{24EI}$  where 24 = constant

- Where
- $\alpha$  = Slope (radians)
  - W = Total load on staybar/slat (N)
  - L = Length of staybar/slat (m)
  - E = Modulus of elasticity ( $210 \times 10^9 \text{ N/m}^2$ )
  - I = Second moment of area ( $\text{m}^4$ )

### CHAIN SPEED VARIATION

All chain sprockets are, in effect, polygons having a number of sides equal to the number of teeth. When sprocket rotation takes place, the chain, on engagement and disengagement, rises and falls relative to the sprocket axis.

The effect of this cyclic variation can be shown in the extreme case of a sprocket with the absolute minimum number of teeth, i.e. three. In this instance, for each revolution of the sprocket the chain is subjected to a three-phase cycle, each phase being associated with the engagement of a single tooth.

As the tooth comes into engagement, for a sixth of a revolution the effective distance, or driving radius from the sprocket centre to the chain is gradually doubled; for the remaining sixth of a revolution, it falls back to its original position. Thus, as the linear speed of the chain is directly related to the effective driving radius of the driver sprockets, the chain speed fluctuates by 50% six times during each revolution of the driver sprocket, (see fig 56).

Fig. 56

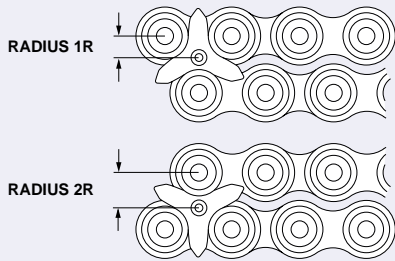

As the graph (fig. 57) shows, the percentage of cyclic speed variation decreases rapidly as more teeth are added. For less than 8 teeth this variation is quite significant:

Fig. 57

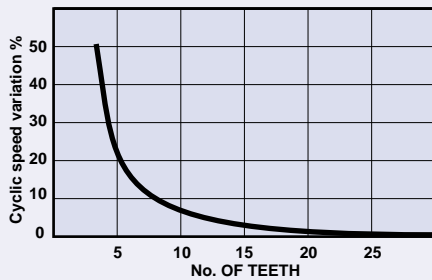
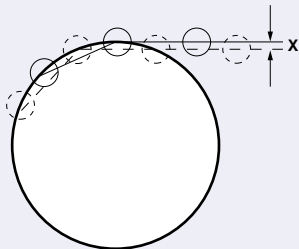

Fig. 58



Actual variations are given in Table 13. These are based on unit pitch chain, therefore 'x' (fig 58) should be multiplied by the actual chain pitch to obtain the finite dimension.

Table 13

Number of Teeth	8	10	12	14	16	18	20	22	24
Factor (x)	0.099	0.079	0.066	0.057	0.049	0.044	0.039	0.036	0.033

The percentage speed variations for typical sprockets are:

Table 14

Number of Teeth	8	10	12	14	16	18	20	22	24
% Speed variation	7.6	4.9	3.4	2.5	1.9	1.5	1.2	1.0	0.9

For example, a chain operating on an 8 tooth sprocket at a nominal speed of 0.5m/sec, will be subject to a theoretical speed variation of between 0.46 and 0.5m/sec.

As can be seen from the graph (fig. 59), as the sprocket rotates the transition from maximum speed is in the form of a smooth curve. However, as the sprocket rotates further there is an increasing deceleration to the minimum speed followed by a rapid acceleration from the minimum speed. This reversal takes the form of an impact of the chain roller (or bush in a bush chain) into the root of the tooth. For slow conveyors this is a very small impact and has little or no effect on the life of the chain. However, if the chain speed is increased significantly, then the impact will have a greater and greater effect on the chain and the sprocket, as well as causing greater noise.

Fig. 59

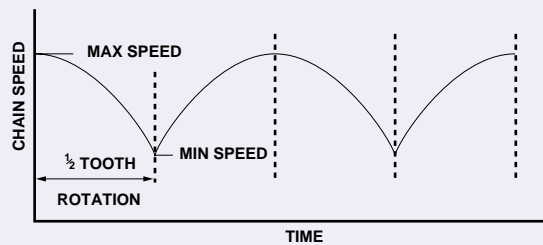

Large chain pitches used on sprockets with a small number of teeth will also cause an increase in the impact. As a result of this the larger the pitch of the chain the lower the recommended maximum chain speed for a sprocket of a given number of teeth. Table 15 shows maximum recommended speeds for chain pitches against numbers of sprocket teeth.

Table 15 Maximum recommended chain speed (m/sec).

Chain Pitch mm (in.)	Number of Teeth					
	8	10	12	16	20	24
50.5 (2")	0.95	1.5	2.2	3.8	5.4	6.5
63	0.86	1.4	2.0	3.5	4.9	5.9
76.2 (3")	0.78	1.2	1.8	3.1	4.4	5.3
80	0.77	1.2	1.7	3.1	4.3	5.3
101.6 (4")	0.68	1.1	1.5	2.7	3.8	4.6
127 (5")	0.61	0.96	1.4	2.4	3.4	4.1
152.4 (6")	0.55	0.86	1.2	2.2	3.1	3.7
160	0.53	0.83	1.2	2.1	3.0	3.6
203.2 (8")	0.47	0.73	1.1	1.9	2.7	3.2
228.6 (9")	0.45	0.70	1.0	1.8	2.5	3.0
254 (10")	0.42	0.65	0.96	1.7	2.4	2.9
304.8 (12")	0.39	0.61	0.88	1.6	2.2	2.6
315	0.38	0.60	0.87	1.5	2.2	2.6

### CHAIN AND SPROCKET LAYOUT

In a conveyor or elevator where two chains and four sprockets are employed it is normal practice to keyway the driving sprockets to the shaft as a pair. The teeth should be in line to ensure equal load sharing. When a pair of sprockets is mounted on a shaft the long bosses of the sprockets should be assembled so as to face each other, i.e. towards the shaft mid point. This allows the sprockets to lie close to the shaft bearings, giving maximum support to the load, while at the same time requiring only the minimum width of conveyor structure. It is usual to secure the sprockets to the shaft with gib-head taper keys, the key head being at the long boss end. Non-driving, or tail sprockets on the same shaft are arranged so that one sprocket only is keyed to the shaft, the other being free to rotate, so accommodating minor differences in phasing between the chain strands.

The un-keyed sprocket should be located between fixed collars secured to the shaft on each side. The free tail sprocket may have a phosphor bronze or similar bush, but generally this is not necessary since the relative movement between the free sprocket and shaft is small.

In the case of more complex installations, such as two-chain conveyors having several stages, the free sprockets should alternate from one side to the other along the circuit path. In this way the slight increase in load pull imposed by the effort of turning the shaft is distributed more evenly over both the chains. It is also important where sprockets of less than 12 teeth are used to check the amount of chain lap on each sprocket. This should be a whole number multiple of

$$\frac{360^\circ}{N}, \text{ where } N = \text{number of teeth.}$$

i.e. for an 8 tooth sprocket the chain lap should be a whole number multiple of  $\frac{360}{8}$ , which is  $45^\circ$ .

Fig. 60

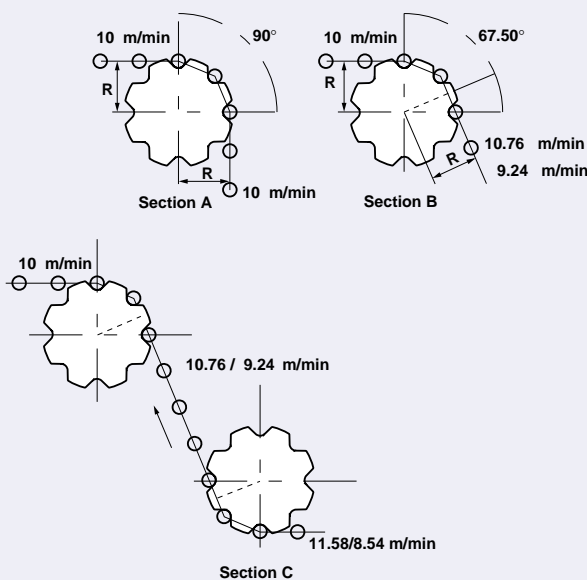

If this guideline is followed then the effective radius of the chain will be the same at entry and exit from the sprocket, (see fig 60 section A). Thus there will be no further variation in chain speed due to polygon effect. However, if the lap angle varies to say  $67\frac{1}{2}^\circ$  for an 8 tooth sprocket (i.e.  $1.5 \times 45^\circ$ ) the radii at entry and exit will be at the maximum variation (see fig. 60 section B). This will mean that if a chain is being pulled at a constant 10 m/min, the chain speed at the entry to the sprocket will vary from 10.76 to 9.24 m/min for each tooth rotation. This will result in a jerky motion in the chain and the faster the chain travels the worse the situation will become. If this situation is followed by a further lap angle of the same value a further variation will occur, which compounds the first, making an even worse situation. (see fig. 60 section C).

### Calculation of sprocket boss stress

In some circumstances it is necessary to bore and keyway a sprocket to just over the maximum recommended bore size. To establish if the standard boss will be satisfactory, or whether a sprocket with a larger boss will be required, it is necessary to calculate the stress in the boss.

This can be done using the following formula, or by contacting Renold for advice.

Fig. 61

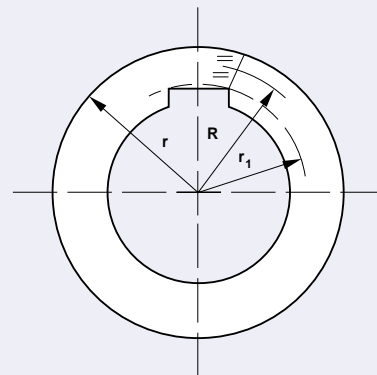

D = Distance through boss (mm)

T = Torque transmitted (Nm)

r = Boss outside radius (mm)

r<sub>1</sub> = Radius to top corner of keyway (mm)

R = Radius to midway between boss outside rad (r) and keyway corner radius (r<sub>1</sub>) (mm)

f = Tensile stress above keyway (N/mm<sup>2</sup>)

$$f = \frac{T \times 1000}{R \times D \times (r - r_1)}$$

The stress concentration factor at the corner of the keyway is approximately 2.25. Therefore, it is usual practice to apply a minimum factor of safety of 6 to the calculated value of f to allow for this.

Based upon a factor of safety of 6 on U.T.S the maximum allowable stresses are:

Cast Iron	-	57.29 N/mm <sup>2</sup>
Carbon Steel (080 M40)	-	110.43 N/mm <sup>2</sup>
Mild Steel	-	72.00 N/mm <sup>2</sup>

### SHAFT DIAMETERS

Having selected the size of conveyor chain required for a system, another important consideration is the diameter of the sprocket shafts. The headshaft takes the greatest stress and this is where attention is focused.

Most conveyor systems use two strands of conveyor chain and the headshaft is driven usually by either a transmission chain drive or by an in-line motorised reduction gearbox.

Stresses are induced in the shaft material by bending and twisting moments, and these need to be evaluated first in order to select a suitable shaft size see page 95 table 16.

#### SIMPLE CONVEYOR HEADSHAFT DIAGRAM

Fig. 62

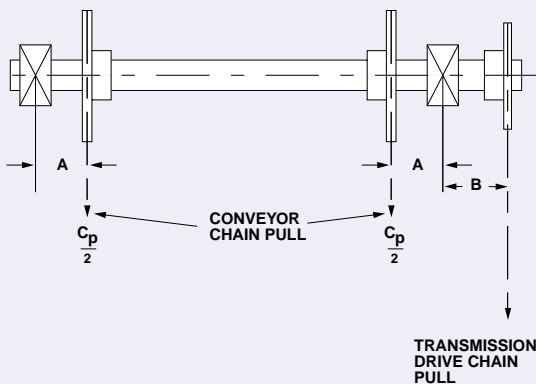

- A = Distance from shaft bearing to nearest conveyor sprocket.
- B = Distance from shaft bearing to transmission chain sprocket.

#### CALCULATION OF BENDING MOMENT - FIG 62

The maximum bending moment induced in the conveyor headshaft may be related either to the transmission drive chain pull, or the conveyor chain pull. The diagram shows a simple headshaft arrangement where the two conveyor sprockets are located equidistant from the respective nearby shaft bearings (distance A), whilst the transmission chain sprocket (if applicable) is positioned on the overhanging shaft, a distance B from the nearest bearing.

Assuming both strands of conveyor chain are experiencing equal tension then the bending moment due to the conveyor chain pull will be half the total chain pull C<sub>p</sub>(N) multiplied by distance A(m). Hence,

$$\text{Bending Moment } M_C = \frac{C_p A}{2} \text{ (Nm)}$$

By comparison, the bending moment due to the transmission chain pull will be the transmission chain pull (N) multiplied by distance B (m). Hence,

Bending moment  $M_T = \text{Chain Pull} \times B \text{ (Nm)}$ , where

$$\text{Transmission chain pull (N)} = \frac{\text{headshaft torque (Nm)} \times 2}{\text{pcd of transmission chain sprocket (m)}}$$

#### CALCULATION OF TWISTING MOMENT (TORQUE) - FIG 62

The maximum twisting moment or headshaft torque is the product of the total conveyor chain pull (N) and the pitch circle radius of the conveyor sprocket (m). Hence,

$$\text{Twisting moment (Nm)} = \frac{C_p \times \text{pcd}}{2}$$

The greater of the two bending moment values calculated as above, along with the twisting moment are now used to establish the constant

$$K = \frac{\text{Max Bending Moment (Nm)}}{\text{Twisting Moment (Nm)}}$$

Page 95 table 16 gives the method for determining shaft diameters based on the use of mild steel bar of 430/490 N/mm<sup>2</sup> (28/32 tons/in<sup>2</sup>) tensile strength. If a shaft is subjected to a twisting moment only, the diameter can be determined from columns 1 and 3. In the more usual situation a shaft subjected to both bending and twisting moments must be selected from column 2 and the appropriate column 'K'.

When selecting a shaft subjected to twisting moments only, first determine the ratio  $\frac{KW}{\text{rev/min}}$  and then select a shaft diameter

from column 3, making any interpolations which may be required. When selecting a shaft subjected to both bending and twisting, having calculated a value for K, select the shaft diameter by reference to column 2 (twisting moment) and the appropriate column 'K'.

As a general rule, for a two strand chain system with sprockets mounted close to the bearings, it is generally found that the ratio 'K' will not exceed 1.0.

Table 16

1 kW/ rev/min	2 Twisting moment  T Nm	3 Shaft diameters (minimum)		K			
		For twisting only  mm	For bending and twisting				
			K = 0.5 mm	K = 0.75 mm	K = 1.0 mm	K = 1.58 mm	
0.009	87	19.13	22.38	24.08	25.63	28.47	
0.019	181	24.46	28.60	30.81	32.77	36.42	
0.037	362	30.81	36.27	38.81	41.28	45.87	
0.056	544	35.28	41.25	44.45	47.29	52.58	
0.075	726	38.84	45.42	48.92	52.07	57.84	
0.112	1089	44.45	51.99	55.93	59.56	66.22	
0.149	1452	48.92	57.28	61.60	65.53	72.90	
0.187	1815	52.70	61.65	66.42	70.61	78.49	
0.224	2178	56.01	65.53	70.61	74.93	83.31	
0.261	2541	58.95	68.83	74.17	78.99	87.88	
0.298	2904	61.67	72.14	77.72	82.55	91.95	
0.336	3268	64.11	74.93	80.77	85.85	95.50	
0.373	3631	66.40	77.72	83.57	88.90	99.06	
0.448	4357	70.54	82.55	88.90	94.74	105.16	
0.522	5083	74.30	86.87	93.47	99.57	110.74	
0.597	5809	77.72	90.93	97.79	104.14	115.82	
0.671	6535	80.77	94.49	101.85	108.20	120.40	
0.746	7261	83.57	97.79	105.16	112.01	124.46	
0.933	9077	90.17	105.41	113.54	120.90	134.37	
1.119	10892	95.76	112.01	120.65	128.27	142.75	
1.306	12707	100.84	117.86	127.00	135.13	150.37	
1.492	14523	105.41	123.44	132.84	141.22	156.97	
1.679	16338	109.73	128.27	138.18	147.07	163.58	
1.865	18153	113.54	132.84	143.00	152.40	169.16	
2.052	19969	117.09	136.91	147.57	156.97	174.50	
2.238	21784	120.65	141.22	151.89	161.80	179.83	
2.425	23599	123.95	145.03	156.21	166.12	184.66	
2.611	25415	127.00	148.59	160.02	170.18	189.23	
2.798	27230	130.05	152.15	163.83	174.24	193.80	
2.984	29045	132.84	155.45	167.39	178.05	198.12	
3.171	30860	135.64	158.75	170.94	181.86	202.18	
3.357	32676	138.18	161.54	173.99	185.42	205.99	
3.544	34491	140.72	164.59	177.29	188.72	209.80	
3.730	36306	143.00	167.39	180.34	191.77	213.11	
4.103	39937	147.83	172.97	186.18	198.12	220.22	
4.476	43568	152.15	178.05	191.77	203.96	226.82	
4.849	47198	156.21	182.88	196.85	209.55	232.92	
5.222	50829	160.02	187.20	201.68	214.63	238.51	

1 kilowatt = 1.34 hp - 1 newton = 0.10197 kg

## MATERIAL CHARACTERISTICS

The values included in table 17 are for approximate density, abrasive index from 1 to 3 where 1 is non abrasive, 2 is mildly abrasive and 3 is highly abrasive, and any special features of the material that should be taken into account in any conveyor design. The values in the tables are given as a guide only, please contact Renold for further advice.

Table 17

Material	Density kg/m <sup>3</sup>	Abrasive Index	Special Properties
Alum	720-960	1	
Alumina	800-960	3	
Aluminium chips	110-240	1	Interlocks and mats
Aluminium hydrate	290	1	
Aluminium oxide	1070-1920	2	Aerates
Aluminium silicate	785	1	
Ammonium chloride, crystalline	830	1	
Ammonium nitrate	720	2	Corrosive, hygroscopic
Ammonium sulphate	720	2	
Ashes, coal, dry 12mm and under	560	2	
Ashes, coal, wet, 12mm and under	720-800	2	Mildly corrosive, packs under pressure
Asphalt, crushed, 12mm and under	720	2	
Bagasse	110-160	1	Interlocks and packs under pressure
Baking powder (NaHCO <sub>3</sub> )	660	1	
Barite	2560	3	
Barium carbonate	1150	2	
Bark, wood, refuse	160-320	2	Interlocks and mats
Barley	610	1	Contains explosive dust
Bauxite, crushed, 75mm and under	1200-1360	3	
Bentonite, crude	545-640	2	Packs under pressure
Bicarbonate of soda (H:CO <sub>3</sub> )	660	1	
Blood, dried	560-720	2	
Bones	560-800	-	
Bonechar, 15mm and under	430-640	2	
Bonemeal	880-960	2	
Borate of lime		1	
Borax, fine	850	1	
Bread crumbs		1	Degradable
Brewer's grain, spent, dry	400-480	1	
Brewer's grain, spent, wet	880-960	1	Mildly corrosive
Bronze chips	480-800	3	
Calcium carbide	1120-1280	2	
Calcium lactate	415-460	1	Degradable - packs under pressure
Calcium Oxide (Quicklime)	1530	1	
Carbon black powder	65-95	1	
Carborundum, 75mm and under	1000	3	
Cast iron chips	2080-3200	2	
Cement, Portland	1040-1360	2	Aerates
Cement clinker	1200-1280	3	
Chalk, lumpy	1360-1440	2	Packs under pressure

The values in the tables are given as a guide only, please contact Renold for further advice.

Table 17

Material	Density kg/m <sup>3</sup>	Abrasive Index	Special Properties
Chalk, 100 mesh and under	1120-1200	2	Aerates and packs under pressure
Charcoal	290-400	2	Degradable
Cheese, grated	350-380	1	Very light and fluffy, packs under pressure
Chrome, ore	2000-2240	3	
Cinders, blast furnace	910	3	
Cinders, coal	640	3	
Clay, calcined	1280	3	Contains toxic dust
Clay, fine dry	1600-1920	3	
Clover seed	770	1	Contains explosive dust
Coal, anthracite	960	2	Mildly corrosive
Coal char	380	2	Contains explosive dust, aerates
Cocoa beans	480-640	2	Degradable
Cocoa powder	480-560	1	Packs under pressure
Coconut, shredded	320-350	1	
Coffee, ground	400	1	
Coffee, roasted bean	350-410	1	
Coke, loose	370-510	3	Degradable, interlocks
Coke, petroleum, calcined	560-720	3	Interlocks
Coke, breeze, 6mm and under	400-560	3	
Compost	450	1	Highly corrosive
Copper ore	1920-2400	3	
Copper sulphate		1	
Copra cake, lumpy	400-480	1	
Copra cake, ground	640-720	1	
Copra meal	640-720	1	
Cork, fine ground	190-240	1	Very light and fluffy, aerates
Cork, granulated	190-240	1	
Corn, cracked	720-800	1	
Corn, seed	720	1	Contains explosive dust, degradable
Corn, shelled	720	1	Contains explosive dust
Corn germs	335	1	
Cornmeal	610-640	1	
Cryolite	1760	2	
Cullet	1280-1920	3	
Diatomaceous earth (Kieselguhr)	175-225	3	Aerates, packs under pressure
Dicalcium phosphate (Calcium Dihydrogen Phosphate)	690	1	
Disodium phosphate (Disodium Hydrogen Phosphate (V))	400-500	2	Mildly corrosive, degradable
Dolomite, lumpy	1440-1600	2	
Ebonite, crushed, 12mm and under	1040-1120	1	
Egg powder	225		

The values in the tables are given as a guide only, please contact Renold for further advice.



Table 17

Material	Density kg/m <sup>3</sup>	Abrasive Index	Special Properties
Epsom salts (magnesium sulphate)	640-800	1	
Feldspar, ground, 15mm and under	2040-2240	3	
Feldspar, powdered	1200	2	
Ferrous sulphate	800-1200	2	
Fish meal	560-640	1	
Fish scrap	640-800	1	
Flaxseed	720	1	Contains explosive dust
Flour, wheat	560-640	1	Easily contaminated
Flue dust, boiler house, dry	560-720	3	Aerates
Fluorspar	1310	2	
Fuller's earth, oil filter, burned	640	3	
Fuller's earth, oil filter, raw	560-640	2	
Gelatin, granulated	510	1	Degradable
Glass batch	1440-1600	3	
Gluten meal	640	1	
Grains, distillery, spent, dry	480	1	Very light and fluffy
Graphite, flake	640	1	
Graphite, flour	450	1	Aerates
Granite, broken	1520-1600	3	
Grass seed	160-190	1	Contains explosive dust, fluffy
Gravel, screened	1440-1600	2	
Gypsum, calcined, 12mm and under	880-960	2	
Gypsum, calcined, powdered	960-1280	2	
Gypsum, raw, 25mm and under	1440-1600	2	
Hops, spent, dry	560	1	
Hops, spent, wet	800-880	1	Mildly corrosive
Ice, crushed	560-720	1	
Ilmenite ore (Iron Titanate)	2240	3	
Iron ore	2000-2400	3	
Kaolin clay, 75mm and under	2610	2	
Kaolin talc, 100 mesh and under	670-900	2	
Lactose	510	1	Easily contaminated, packs under pressure
Lead arsenate	1155	1	Gives off toxic dust
Lignite, air dried	720-880	1	
Lignite, raw	640-720	2	
Lime, ground, 3mm and under	960	1	Packs under pressure
Lime, hydrated, 3mm and under	640	1	Aerate, packs under pressure
Lime, hydrated, pulverized	510-640	1	Aerates, packs under pressure
Lime, pebble	860-900	1	Aerates, packs under pressure
Limestone, crushed	1360-1440	2	

The values in the tables are given as a guide only, please contact Renold for further advice.

Table 17

Material	Density kg/m <sup>3</sup>	Abrasive Index	Special Properties
Limestone dust	1200	2	Aerates
Lithopone (BaSC <sub>2</sub> )	720-800	1	Aerates
Magnesium chloride	530	1	
Malt, dry ground 3mm and under	350	1	Contains explosive dust, light and fluffy
Malt, dry whole	430-480	1	Contains explosive dust
Malt, wet or green	960-1040	1	
Malt meal	575-640	1	
Manganese dioxide	1280	2	
Manganse ore	2000-2240	3	
Manganese sulphate	1120	3	
Marble, crushed, 12mm and under	1440-1520	3	
Marl	1280	2	
Meat, ground	800-880	2	
Meat, scraps	640	2	Interlocks and matts
Mica, ground	210-240	2	
Mica, pulverized	210-240	2	Aerates
Mica flakes	270-350	2	Aerates, very light and fluffy
Milk, dried flake	80-95	1	Easily contaminated
Milk, malted	480-560	1	Easily contaminated, packs under pressure
Milk, whole powdered	320	1	Easily contaminated, packs under pressure
Monosodium phosphate	800	2	
Muriate of potash	1230	3	
Mustard seed	720	1	Contains explosive dust
Naphthalene flakes	720	1	Mildly corrosive
Niacin	560	2	
Nickel-cobalt sulphate ore	1120-1280	3	
Oats	415	1	Contains explosive dust
Oil seed rape	770 / 880		
Orange peel, dry	240	1	
Oxalic acid crystals	960	1	Hygroscopic
Oyster shells, ground under 12mm	850	2	
Oyster shells, whole		2	Interlocks and matts
Palm oil, fresh fruit bunches	432-513	2	
Palm oil, empty fruit bunches	202-238	2	
Palm oil, fresh loose fruit	609-641	2	
Palm oil, sterilised stripped fruit	641-705	1	
Palm oil, nuts	659-705	2	
Palm oil, shell	593-609	2	
Paper pulp, 10% consistency	720-800	1	Corrosive
Paper pulp, 20% consistency	400-480	1	Mildly Corrosive
Paper pulp, 30% consistency	160-240	1	Mildly Corrosive

The values in the tables are given as a guide only, please contact Renold for further advice.

Table 17

Material	Density kg/m <sup>3</sup>	Abrasive Index	Special Properties
Peanuts, in shells	240-320	1	Degradable
Peanuts, shelled	560-720	1	Degradable
Peas, dried	720-800	1	Contains explosive dust, degradable
Phosphate rock	1200-1360	2	
Phosphate sand	1440-1600	3	
Phosphorous	1510	2	
Polystyrene beads	640	1	
Potassium carbonate	820	2	
Potassium chloride, pellets	1920-2080	2	Mildly corrosive
Potassium nitrate	1220	2	Mildly corrosive
Potassium sulphate	670-770	2	Packs under pressure
Pumice, 3mm and under	670-720	3	
Pyrites, pellets	1920-2080	2	
Quartz powder	1240	3	
Rape seed	770/880		
Rice, hulled or polished	720-770	1	
Rice, rough	575	1	Contains explosive dust
Rubber, pelletized	800-880	1	
Rubber, reclaim	400-480	1	
Rye	705	1	Contains explosive dust
Salicylic acid	465	1	Hygroscopic
Salt, common, dry course	720-800	2	Mildly corrosive, hygroscopic
Salt, common, dry fine	1120-1280	2	Mildly corrosive, hygroscopic
Salt cake, dry course	1360	2	
Salt cake, dry pulverized	1040-1360	2	
Saltpetre	1280	1	Contains explosive dust
Sand, bank, damp	1760-2080	3	
Sand, bank, dry	1440-1760	3	
Sand, foundry, prepared	1440	3	
Sand, foundry, shakeout	1440	3	
Sand, silica, dry	1440-1600	3	
Sawdust	160-210	1	Contains explosive dust
Sesame seed	430	2	
Shale, crushed	1360-1440	2	
Shellac, powdered or granulated	500	1	Easily contaminated
Silica gel	720	3	
Slag, furnace, granular	960-1040	3	
Slag, furnace, lumpy	2560-2880	3	Interlocks and matts
Slate, crushed, 12mm and under	1280-1440	2	
Slate, ground, 3mm and under	1310	2	
Soap beads or granules		1	Degradable
Soap chips	240-400	1	Degradable
Soap detergents	240-800	1	Mildly corrosive, degradable
Soap flakes	80-240	1	Degradable
Soap powder	320-400	1	
Soapstone talc, fine	640-800	2	Packs under pressure

The values in the tables are given as a guide only, please contact Renold for further advice.

Table 17

Material	Density kg/m <sup>3</sup>	Abrasive Index	Special Properties
Soda ash, heavy	880-1040	2	
Soda ash, light	320-560	2	Very light and fluffy
Sodium nitrate	1120-1280		Corrosive
Sorghum seed	750-830	2	
Soybeans, cracked	480-640	2	Contains explosive dust
Soybeans, whole	720-800	2	Contains explosive dust
Soybean cake, over 12mm	640-690	1	
Soybean flakes, raw	320-415	1	Very light and fluffy
Soybean flakes, spent	290-320	1	Very light and fluffy
Soybean flour	430		
Soybean meal, cold	640	1	
Soybean meal, hot	640	1	Mildly corrosive
Starch	400-800		Mildly corrosive
Steel chips, crushed	1600-2400	3	
Steel turnings	1200-2400	3	Interlocks and matts
Sugar, granulated	800-880	1	Easily contaminated, contains explosive dust
Sugar, powdered	800-960	1	Easily contaminated, contains explosive dust
Sugar, raw, cane	880-1040	1	Packs under pressure
Sugar, wet, beet	880-1040	1	Packs under pressure
Sugar beet, pulp, dry	190-240	2	Mildly corrosive
Sugar beet, pulp, wet	400-720	2	Corrosive
Sugar cane, knifed	240-290	2	Corrosive, interlocks and matts
Sulphur, crushed, 12mm and under	800-960	1	Contains explosive dust
Sulphur, 75mm and under	1280-1360	1	Contains explosive dust
Sulphur, powdered	800-960	1	Contains explosive dust, aerates
Talcum powder	640-960	2	Aerates
Titanium sponge	960-1120	3	
Tobacco leaves, dry	190-225	1	Degradable, interlocks and matts
Tobacco scraps	240-400	1	Very light and fluffy
Tobacco snuff	480	1	Degradable, aerates
Tobacco stems	240	1	Interlocks and matts
Trisodium phosphate (sodium Orthophosphate)	960	2	
Triple super phosphate (Calcium Phosphate (V))	800-880	2	Highly corrosive, gives off toxic fumes
Urea	640	1	
Vermiculite, expanded	225	2	Very light and fluffy
Vermiculite ore	1280	2	
Walnut shells, crushed	560-640	3	
Wheat	720-770	1	Contains explosive dust
Wheat, cracked	640-720	1	Contains explosive dust
Wheat germ	450	1	
Wood chips	160-480	1	Very light and fluffy, interlocks and matts
Zinc concentrate residue	1200-1280	3	
Zinc ore, crushed	2560	3	
Zinc oxide, heavy	480-560	1	Packs under pressure
Zinc oxide, light	160-240	1	Very light, packs under pressure

The values in the tables are given as a guide only, please contact Renold for further advice.

## RESISTANCE OF STEELS TO CORROSION

Table 18

Material	Formula	Steel Type		
		A	B	C
Acetic Acid	CH <sub>3</sub> COOH	3	2	1
Alcohol	C <sub>2</sub> H <sub>5</sub> OH	1	1	1
Ammonia	NH <sub>3</sub>	2	1	1
Acetone (Propanone)	CH <sub>3</sub> COCH <sub>3</sub>	3	1	1
Aluminium Chloride	AlCl <sub>3</sub>	3		
Aluminium Silicate		2	1	1
Ammonium Chloride	NH <sub>4</sub> Cl	3	2	1
Ammonium Nitrate	NH <sub>4</sub> NO <sub>3</sub>	2	1	1
Ammonium Sulphate	(NH <sub>4</sub> ) <sub>2</sub> SO <sub>4</sub>	2	1	1
Beer		2	1	1
Benzene	C <sub>6</sub> H <sub>6</sub> (OH) <sub>2</sub>	1	1	1
Borax (Disodium Tetraborate)	Na <sub>2</sub> B <sub>4</sub> O <sub>7</sub> ·10H <sub>2</sub> O	2	1	1
Brine		3	2	1
Carbon Tetrachloride (Tetrachloroethane)	CCl <sub>4</sub>	3	2	1
Caustic Soda Solution		1	1	1
Citric Acid	C <sub>3</sub> H <sub>5</sub> O(COOH) <sub>3</sub>	3	2	1
Coal		2	1	1
Cocoa Beans		1	1	1
Cocoa Powder		2	2	1
Formaldehyde (Methanal)	HCHO	1	1	1
Formic Acid (Methanoic Acid)	HCOOH	3	3	3
Fruit Juices		3	1	1
Hydrochloric Acid (2%)	HCL	3	3	3
Hydrogen Peroxide	H <sub>2</sub> O <sub>2</sub>	3	1	1
Hypochlorite Soda (Chlorate)	ClO <sub>3</sub>	3	3	3
Iodine		3	3	3
Iron Pyrites	FeS <sub>2</sub>	2	1	1
Lactic Acid	CH <sub>3</sub> CH(OH)COOH	3	2	1
Lead Ores (Galena)	PbS	2	1	1
Milk		1	1	1
Nitric Acid (Low Concentrate)	HNO <sub>3</sub>	3	2	1
Oil (Vegetable & Mineral)		1	1	1
Oxalic Acid (Ethanedioic Acid)	(COOH) <sub>2</sub>	3	3	3
Paraffin (Alkanes)	C <sub>n</sub> H <sub>2n</sub>	1	1	1
Phosphate Fertiliser	H <sub>3</sub> PO <sub>4</sub>	3	1	1
Potassium Carbonate (Potash)	K <sub>2</sub> CO <sub>3</sub>	2	1	1
Potassium Chloride (Potassium Muriate)	KCl	2	1	1
Petrol (Gasoline)		1	1	1
Phosphoric Acid	H <sub>3</sub> PO <sub>4</sub>	3	2	1
Sea Water		3	2	2
Soaps and Solutions		2	1	1
Sodium Chloride	NaCl	3	2	2
Sugar	C <sub>12</sub> H <sub>22</sub> O <sub>11</sub>	2	1	1
Sulphur	S	3	2	2
Sulphuric Acid	H <sub>2</sub> SO <sub>4</sub>	3	3	3
Vegetable Juices		2	1	1
Vegetable Oils		1	1	1
Vinegar		3	2	1
Water	H <sub>2</sub> O	3	1	1
Whisky		1	1	1
Wine		1	1	1

### Explanation of the Table

#### Steel type

- A Represents carbon steels
- B Represents martensitic stainless steels, i.e. AISI 420 or similar
- C Represents austenitic stainless steels AISI 316 or similar

#### Levels of Resistance

- 1 Fully resistant
- 2 Partially resistant
- 3 Not resistant

Please note that the table is for determining corrosion resistance only. A material may be satisfactory from the point of view of corrosion but may be affected by other factors, such as abrasion. All factors should be checked before a material is finally selected.

TABLE OF  $\mu_s1$

CHAIN REF	UTS (kN)	ROLLER DIA (mm)	LUBRICATION	CONVEYOR INCLINATION							
				0°	5°	10°	15°	20°	30°	40°	50°
BS13	13	25.4	R	0.13	0.04	-0.05	-0.13	-0.22	-0.39	-0.54	-0.68
			O	0.14	0.05	-0.04	-0.12	-0.21	-0.38	-0.54	-0.68
			N	0.16	0.07	-0.02	-0.10	-0.19	-0.36	-0.52	-0.66
BS20	20	25.4	R	0.15	0.06	-0.03	-0.11	-0.20	-0.37	-0.53	-0.67
			O	0.17	0.08	-0.01	-0.09	-0.18	-0.35	-0.51	-0.66
			N	0.19	0.10	0.01	-0.08	-0.16	-0.34	-0.50	-0.64
BS27/BS33	27/33	31.8	R	0.15	0.06	-0.03	-0.11	-0.20	-0.37	-0.53	-0.67
			O	0.18	0.09	0.00	-0.08	-0.17	-0.34	-0.50	-0.65
			N	0.20	0.11	0.02	-0.07	-0.15	-0.33	-0.49	-0.64
BS54/BS67	54/67	47.6	R	0.12	0.03	-0.06	-0.14	-0.23	-0.40	-0.55	-0.69
			O	0.14	0.05	-0.04	-0.12	-0.21	-0.38	-0.54	-0.68
			N	0.17	0.08	-0.01	-0.09	-0.18	-0.35	-0.51	-0.66
BS107/BS13	107/134	66.7	R	0.10	0.01	-0.08	-0.16	-0.25	-0.41	-0.57	-0.70
			O	0.13	0.04	-0.05	-0.13	-0.22	-0.39	-0.54	-0.68
			N	0.15	0.06	-0.03	-0.11	-0.20	-0.37	-0.53	-0.67
BS160/BS20	160/200	88.9	R	0.09	0.00	-0.09	-0.17	-0.26	-0.42	-0.57	-0.71
			O	0.11	0.02	-0.07	-0.15	-0.24	-0.40	-0.56	-0.70
			N	0.13	0.04	-0.05	-0.13	-0.22	-0.39	-0.54	-0.68
BS267	267	88.9	R	0.09	0.00	-0.09	-0.17	-0.26	-0.42	-0.57	-0.71
			O	0.11	0.02	-0.07	-0.15	-0.24	-0.40	-0.56	-0.70
			N	0.13	0.04	-0.05	-0.13	-0.22	-0.39	-0.54	-0.68
BS400	400	88.9	R	0.09	0.00	-0.09	-0.17	-0.26	-0.42	-0.57	-0.71
			O	0.11	0.02	-0.07	-0.15	-0.24	-0.40	-0.56	-0.70
			N	0.13	0.04	-0.05	-0.13	-0.22	-0.39	-0.54	-0.68
M40	40	36	R	0.11	0.02	-0.07	-0.15	-0.24	-0.40	-0.56	-0.70
			O	0.12	0.03	-0.06	-0.14	-0.23	-0.40	-0.55	-0.69
			N	0.14	0.05	-0.04	-0.12	-0.21	-0.38	-0.54	-0.68
M56	56	42	R	0.10	0.01	-0.08	-0.16	-0.25	-0.41	-0.57	-0.70
			O	0.12	0.03	-0.06	-0.14	-0.23	-0.40	-0.55	-0.69
			N	0.14	0.05	-0.04	-0.12	-0.21	-0.38	-0.54	-0.68
MC56	56	50	R	0.10	0.01	-0.08	-0.16	-0.25	-0.41	-0.57	-0.70
			O	0.12	0.03	-0.06	-0.14	-0.23	-0.40	-0.55	-0.69
			N	0.14	0.05	-0.04	-0.12	-0.21	-0.38	-0.54	-0.68
M80	80	50	R	0.09	0.00	-0.09	-0.17	-0.26	-0.42	-0.57	-0.71
			O	0.11	0.02	-0.07	-0.15	-0.24	-0.40	-0.56	-0.70
			N	0.13	0.04	-0.05	-0.13	-0.22	-0.39	-0.54	-0.68
M112	112	60	R	0.09	0.00	-0.09	-0.17	-0.26	-0.42	-0.57	-0.71
			O	0.10	0.01	-0.08	-0.16	-0.25	-0.41	-0.57	-0.70
			N	0.12	0.03	-0.06	-0.14	-0.23	-0.40	-0.55	-0.69
MC112	112	70	R	0.09	0.00	-0.09	-0.17	-0.26	-0.42	-0.57	-0.71
			O	0.11	0.02	-0.07	-0.15	-0.24	-0.40	-0.56	-0.70
			N	0.13	0.04	-0.05	-0.13	-0.22	-0.39	-0.54	-0.68
M160	160	70	R	0.08	-0.01	-0.09	-0.18	-0.27	-0.43	-0.58	-0.71
			O	0.10	0.01	-0.08	-0.16	-0.25	-0.41	-0.57	-0.70
			N	0.12	0.03	-0.06	-0.14	-0.23	-0.40	-0.55	-0.69
M224	224	85	R	0.08	-0.01	-0.09	-0.18	-0.27	-0.43	-0.58	-0.71
			O	0.09	0.00	-0.09	-0.17	-0.26	-0.42	-0.57	-0.71
			N	0.11	0.02	-0.07	-0.15	-0.24	-0.40	-0.56	-0.70
MC224	224	100	R	0.08	-0.01	-0.09	-0.18	-0.27	-0.43	-0.58	-0.71
			O	0.10	0.01	-0.08	-0.16	-0.25	-0.41	-0.57	-0.70
			N	0.12	0.03	-0.06	-0.14	-0.23	-0.40	-0.55	-0.69
M315	315	100	R	0.07	-0.02	-0.10	-0.19	-0.28	-0.44	-0.59	-0.72
			O	0.09	0.00	-0.09	-0.17	-0.26	-0.42	-0.57	-0.71
			N	0.11	0.02	-0.07	-0.15	-0.24	-0.40	-0.56	-0.70
M450	450	120	R	0.07	-0.02	-0.10	-0.19	-0.28	-0.44	-0.59	-0.72
			O	0.09	0.00	-0.09	-0.17	-0.26	-0.42	-0.57	-0.71
			N	0.10	0.01	-0.08	-0.16	-0.25	-0.41	-0.57	-0.70
M630	630	140	R	0.07	-0.02	-0.10	-0.19	-0.28	-0.44	-0.59	-0.72
			O	0.09	0.00	-0.09	-0.17	-0.26	-0.42	-0.57	-0.71
			N	0.10	0.01	-0.08	-0.16	-0.25	-0.41	-0.57	-0.70
M900	900	170	R	0.06	-0.03	-0.11	-0.20	-0.29	-0.45	-0.60	-0.73
			O	0.08	-0.01	-0.09	-0.18	-0.27	-0.43	-0.58	-0.71
			N	0.10	0.01	-0.08	-0.16	-0.25	-0.41	-0.57	-0.70

R = REGULAR O = OCCASIONAL N = NONE

# Designer Guide

TABLE OF  $\mu_{s2}$

CHAUN REF.	UTS (kN)	ROLLER DIA (mm)	LUBRICATION	CONVEYOR INCLINATION							
				0°	5°	10°	15°	20°	30°	40°	50°
BS13	13	25.4	R	0.13	0.22	0.30	0.38	0.46	0.61	0.74	0.85
			O	0.14	0.23	0.31	0.39	0.47	0.62	0.75	0.86
			N	0.16	0.25	0.33	0.41	0.49	0.64	0.77	0.87
BS20	20	25.4	R	0.15	0.24	0.32	0.40	0.48	0.63	0.76	0.86
			O	0.17	0.26	0.34	0.42	0.50	0.65	0.77	0.88
			N	0.19	0.28	0.36	0.44	0.52	0.66	0.79	0.89
BS27/BS33	27/33	31.8	R	0.15	0.24	0.32	0.40	0.48	0.63	0.76	0.86
			O	0.18	0.27	0.35	0.43	0.51	0.66	0.78	0.88
			N	0.20	0.29	0.37	0.45	0.53	0.67	0.80	0.89
BS54/BS67	54/67	47.6	R	0.12	0.21	0.29	0.37	0.45	0.60	0.73	0.84
			O	0.14	0.23	0.31	0.39	0.47	0.62	0.75	0.86
			N	0.17	0.26	0.34	0.42	0.50	0.65	0.77	0.88
BS107/BS13	107/134	66.7	R	0.10	0.19	0.27	0.36	0.44	0.59	0.72	0.83
			O	0.13	0.22	0.30	0.38	0.46	0.61	0.74	0.85
			N	0.15	0.24	0.32	0.40	0.48	0.63	0.76	0.86
BS160/BS20	160/200	88.9	R	0.09	0.18	0.26	0.34	0.43	0.58	0.71	0.82
			O	0.11	0.20	0.28	0.37	0.45	0.60	0.73	0.84
			N	0.13	0.22	0.30	0.38	0.46	0.61	0.74	0.85
BS267	267	88.9	R	0.09	0.18	0.26	0.34	0.43	0.58	0.71	0.82
			O	0.11	0.20	0.28	0.37	0.45	0.60	0.73	0.84
			N	0.13	0.22	0.30	0.38	0.46	0.61	0.74	0.85
BS400	400	88.9	R	0.09	0.18	0.26	0.34	0.43	0.58	0.71	0.82
			O	0.11	0.20	0.28	0.37	0.45	0.60	0.73	0.84
			N	0.13	0.22	0.30	0.38	0.46	0.61	0.74	0.85
M40	40	36	R	0.11	0.20	0.28	0.37	0.45	0.60	0.73	0.84
			O	0.12	0.21	0.29	0.37	0.45	0.60	0.73	0.84
			N	0.14	0.23	0.31	0.39	0.47	0.62	0.75	0.86
M56	56	42	R	0.10	0.19	0.27	0.36	0.44	0.59	0.72	0.83
			O	0.12	0.21	0.29	0.37	0.45	0.60	0.73	0.84
			N	0.14	0.23	0.31	0.39	0.47	0.62	0.75	0.86
MC56	56	50	R	0.10	0.19	0.27	0.36	0.44	0.59	0.72	0.83
			O	0.12	0.21	0.29	0.37	0.45	0.60	0.73	0.84
			N	0.14	0.23	0.31	0.39	0.47	0.62	0.75	0.86
M80	80	50	R	0.09	0.18	0.26	0.34	0.43	0.58	0.71	0.82
			O	0.11	0.20	0.28	0.37	0.45	0.60	0.73	0.84
			N	0.13	0.22	0.30	0.38	0.46	0.61	0.74	0.85
M112	112	60	R	0.09	0.18	0.26	0.34	0.43	0.58	0.71	0.82
			O	0.10	0.19	0.27	0.36	0.44	0.59	0.72	0.83
			N	0.12	0.21	0.29	0.37	0.45	0.60	0.73	0.84
MC112	112	70	R	0.09	0.18	0.26	0.34	0.43	0.58	0.71	0.82
			O	0.11	0.20	0.28	0.37	0.45	0.60	0.73	0.84
			N	0.13	0.22	0.30	0.38	0.46	0.61	0.74	0.85
M160	160	70	R	0.08	0.17	0.25	0.34	0.42	0.57	0.70	0.82
			O	0.10	0.19	0.27	0.36	0.44	0.59	0.72	0.83
			N	0.12	0.21	0.29	0.37	0.45	0.60	0.73	0.84
M224	224	70	R	0.08	0.17	0.25	0.34	0.42	0.57	0.70	0.82
			O	0.09	0.18	0.26	0.34	0.43	0.58	0.71	0.82
			N	0.11	0.20	0.28	0.37	0.45	0.60	0.73	0.84
MC224	224	85	R	0.08	0.17	0.25	0.34	0.42	0.57	0.70	0.82
			O	0.10	0.19	0.27	0.36	0.44	0.59	0.72	0.83
			N	0.12	0.21	0.29	0.37	0.45	0.60	0.73	0.84
M315	315	100	R	0.07	0.16	0.24	0.33	0.41	0.56	0.70	0.81
			O	0.09	0.18	0.26	0.34	0.43	0.58	0.71	0.82
			N	0.11	0.20	0.28	0.37	0.45	0.60	0.73	0.84
M450	450	120	R	0.07	0.16	0.24	0.33	0.41	0.56	0.70	0.81
			O	0.09	0.18	0.26	0.34	0.43	0.58	0.71	0.82
			N	0.10	0.19	0.27	0.36	0.44	0.59	0.72	0.83
M630	630	140	R	0.07	0.16	0.24	0.33	0.41	0.56	0.70	0.81
			O	0.09	0.18	0.26	0.34	0.43	0.58	0.71	0.82
			N	0.10	0.19	0.27	0.36	0.44	0.59	0.72	0.83
M900	900	170	R	0.06	0.15	0.23	0.32	0.40	0.55	0.69	0.80
			O	0.08	0.17	0.25	0.34	0.42	0.57	0.70	0.82
			N	0.10	0.19	0.27	0.36	0.44	0.59	0.72	0.83

R = REGULAR O = OCCASIONAL N = NONE